



smartwares®



DASH CAM INSTRUCTIONS

## Includes with

- Car Camera
- Car Charger
- USB Cable
- Suction cup mount

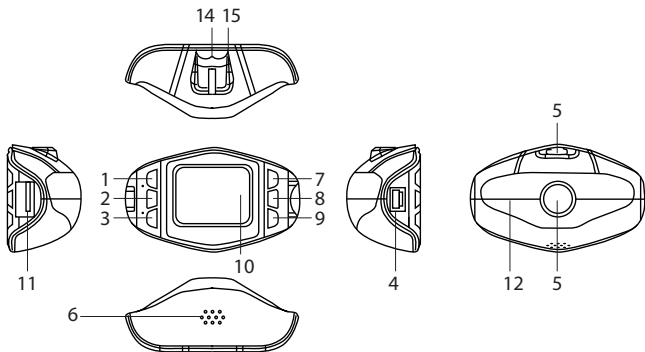

1. Up button
2. Menu
3. Down button
4. USB interface
5. Camera

6. Speaker
7. Ok button
8. Mode button
9. Power button
10. Display screen

11. TF slot
12. LED flash light
13. Bracket hole
14. Reset hole
15. MIC

## 1) Charging

A) Using the built-in rechargeable lithium battery

Charging options:

1) Connect the Dash Cam to the car charger;

2) Connect the dash cam to your computer using the USB cable

- When charging through the car charger, the 'battery' display in the bottom right of the screen will flash – indicating that the unit is charging

- A red light will illuminate on the left side of the Dash cam whenever the camera is charging

(Note: For first charge a minimum of 6 hours is recommended)

B) The Dash Cam connected to the 12v car charger



When the 12v car charger is plugged into your vehicle's 12v outlet and the dash cam is connected; after starting the car, the device automatically turns on and enters video mode – it will begin to record. The device will continue recording while charging. When the car is turned off, the device keeps working and will turn off five seconds later, saving the recorded files automatically (if your vehicle's 12v outlet stays active when the car is turned off, it is recommended to unplug your Dash Cam before leaving your car). Alternatively you can choose to turn the camera off using the power button  the files will be automatically saved.

Note: The Dash Cam is designed to be plugged in continually while driving; leaving the unit plugged in for long periods of time will not harm the camera.

## 2) Functions introduction



This camera has three modes: Video mode, Still Photo mode, Playback mode



To switch between modes, when the camera is NOT recording, press the MODE button 

A) Video mode: (a video camcorder icon will display in the top left of the screen.  Memory card must be inserted) After pressing and holding the power button, or connecting Dash Cam to the car charger, the camera turns on and enters video mode. Dash cam will automatically begin recording. To stop recording, press the OK button.  To turn off the device, press and hold the power button.  Whether you stop recording using the OK button or you simply power down Dash Cam using the power button, your video will be stored.

Note: Pressing the OK button  in video mode starts and stops recording.

Note: Pressing the mode button  while Dash Cam is recording will lock and store the current video – the top of the screen will display this lock key icon.  This video will not be overwritten until the memory card is formatted.



Note: A quick press (less than one second) of the power button  while recording changes Dash Cam from day mode to night mode (the following icon will display on the top of the display screen when in night mode 



Note: Pressing the up button  while recording will zoom the camera in up to 4x digital zoom. Press the down button  to zoom out.

Note: The menu button  has no function while the camera is recording.



B) Still Photo mode: (A still photo camera icon will appear in the top left of the screen.  Memory card must be inserted) After the device is powered on, press the OK button to stop recording. Once recording has been stopped, press the mode button once to enter still photo mode (Dash Cam cannot change modes while the camera is recording).

Note: To capture a photo in still photo mode, press the OK button 

Note: A quick press (less than one second) of the power button  while in still photo mode changes Dash Cam from day mode to night mode (the following icon will display on the top of the display screen when in night mode 

Note: Pressing the up button  while in still photo mode will zoom the camera in up to 4x digital zoom. Press the down button  to zoom out.

C) Preview mode: (A film negative icon  will display in the top left of the screen. To view video, memory card must be inserted)

After the device is powered on, press the OK button to stop recording. Press the MODE button  twice to enter into Preview mode. You can scroll through previews by pressing the UP and DOWN buttons. In the top right of the display screen, the file name is displayed. When the file you wish to playback is displayed on screen, press the OK button to begin playing; the OK button will play and pause the current video. To fast forward a video, use the DOWN button  (up to 8x fast forward speed). To rewind a video, use the UP button  (up to 8x rewind speed).

Note: When playing a video, the video time will display in the top left of the display screen below the file name.

Note: Once a video is playing, the menu button  becomes inactive. Stop the video playback by pressing the mode button  and the menu button will reactivate.

Note: If the file displays the lock icon on the top of the screen  the current video is locked, it can only be deleted by formatting the memory card.

### 3) Instellingen Menu



Each of the Dash Cam's three modes has its own settings menu: Video Settings, Still Settings, Playback Settings.

To access the settings menus from any mode: be sure the camera is NOT recording.









To enter Video settings press the MENU button  from video mode. To access Still

settings, navigate to Still Photo mode and press the MENU button.  To access Playback

settings, navigate to Playback mode and press the MENU button.  Navigate the menus

by using the UP and DOWN buttons   choose the highlighted setting by pressing OK. 

Video settings:











-  Resolution: 1080FHD (1920x1080) / 720P (1280x720) / WVGA (848x480) / VGA (640x480) / QVGA (320x240)
-  Loop Recording: Off / 1 Minute / 3 Minutes / 5 Minutes
-  EV Exposure Value: +2.0, +5/3, +4/3, +1, +2/3, +1/3, 0, -1/3, -2/3, -1.0, -4/3, -5/3, -2.0
-  Motion Detection: On / Off
-  Audio: On / Off
-  Date Stamp: On / Off
-  G Sensor: 2G / 4G / 8G / Off
-  Button Sound: On / Off

Higher resolution has higher picture quality but also takes more memory to store files.

When this option is turned on, the camera will record in, for example, 3 minute video clips when the memory card is full the camera will then overwrite the oldest video file and store the newest, allowing you to continue recording while never having to change the memory card.



The Dash Cam's G Sensor (Gravity Sensor) locks and stores video on sudden impact so it will not be overwritten by the camera's loop recording function. This menu setting adjusts the sensitivity of this sensor with 2G being the most sensitive and 8G being the least.

## Still settings:

	Timer: Single / 2s Timer / 5s Timer / 10s Timer
	Resolution: 12M (4032x3024) / 10M (3648x2736) / 8M (3264x2448) / 5M (2592x1944) / 3M (2048x1536)
	Sequence: On / Off
	Quality: Fine / Normal / Economy
	Sharpness: Strong / Normal / Soft
	White balance: Auto / Daylight / Cloudy / Tungsten / Fluorescent
	Color: Color / B&W / Sepia
	ISO: Auto / 100 / 200 / 400
	EV Exposure Value: +2.0, +5/3, +4/3, +1.0, +2/3, +1/3, +0.0, -1/3, -2/3, -1.0, -4/3, -5/3, -2.0
	Anti-Shaking: On / Off
	Quick Review: Off / 2 seconds / 5 seconds

Note: When sequence is turned 'On,' one press of the OK button **OK** will take a sequence of five pictures Note: When turned on, quick review allows you to quickly review the picture you have just taken for the chosen amount of time.









## Playback Settings:



	Delete: Delete Current? / Delete all?
	Protect: Lock Current / Unlock Current / Lock All / Unlock All

Note: Choosing, 'Delete Current' will delete the file that was on screen when entering the playback settings menu. Choosing, 'Delete all' will delete all unlocked files on the memory card Note: Locked videos cannot be deleted until they are unlocked with one exception; formatting the memory card will erase all files on the memory card – including locked videos.

## Setup Menu:

In addition to the mode settings pages, from any mode you can access the Setup Menu by pressing the MENU button  twice (camera must NOT be recording to access menus).

-  Set Date/Time: Using the UP and DOWN buttons   set the correct time and date.
-  Auto Power Off: Off / 2 Minutes / 5 Minutes / 10Minutes
-  Language: English / French / German / Italian / Spanish / Simplified Chinese / Traditional Chinese / Japanese / Russian / Korean
-  Light Frequency: 50 Hz / 60 Hz (Set to 60 Hz for North America)
-  Screen Saver: 1 Minute / 3 Minutes / 5 Minutes / Off
-  Image Rotate: On/Off (Flips the screen for recording on windshield or dashboard)
-  Format: Cancel / OK
-  Default Setting: Cancel/OK (Resets you're the Camera to factory default settings)
-  Firmware Version: Displays the software version number.

Note: Use the OK button  to navigate between month, day, year and time. Once the correct time and date are displayed, press the MENU button  to activate.

Note: When screen saver is on, The Dash Cam's display screen will shut off after the chosen time of inactivity (1,3,5 minutes), The Dash Cam will continue recording. To turn the screen back on, simply press any button.

Note: CAUTION performing a format of the memory card will erase ALL data on the card, included locked files.

## WARNING

THIS DEVICE SHOULD NOT BE ADJUSTED BY THE DRIVER WHILE DRIVING. IN THE EVENT OF AN ACCIDENT, DEVICE MAY DISLODGE AND BECOME UNSAFE FOR PASSENGERS.

## Notice

- 1) Please insert memory card before recording.
- 2) Supports memory cards up to 32GB.
- 3) Please attach unit by applying firm pressure to mount before mounting on surface.
- 4) When the lithium battery is depleted, The Dash Cam screen shows 'Batteries depleted.' The camera will shut down automatically after 20 seconds and save the files automatically.
- 5) If you need to reset the dash cam, press the RESET button for 3 seconds.

<b>smartwares<sup>®</sup></b> <b>Europe</b>	NL : 088 5940501 Lokaal tarief	<b>CUSTOMER SERVICE</b>
	BE : 078 481094(NL) Lokaal tarief	
	BE : 078 481540(FR) Tarif local	
	FR : 0825 560 650 18ct/min	
Jules Verneweg 87 5015 BH Tilburg The Netherlands	DE: +49 (0) 1805 010762 14Ct./Min. dt. Festnetz, Mobil max. 42Ct./Min	
	UK: +44 (0) 345 230 1231	
<b>service.smartwares.eu</b>	ES : +34 938427589	