



smartwares®

HA700+

Wireless alarm system with built-in phone transmitter

Complete battery operated

Installation & operation manual



TABLE OF CONTENTS

INTRODUCTION AND GENERAL POINTS	3
PRE-PROGRAMMING	3
1. PACKAGE CONTENT	5
2. INSTALLATION PLANNING	6
3. INSTALLING AND PROGRAMMING THE STATION	8
3.1 Installing and programming the alarm station	8
3.1.1 System description	8
3.1.2 Installing the system	9
3.1.3 Programming the personal code	11
3.1.4 Setting the trigger mode	11
3.1.5 Entry delay	11
3.1.6 Alarm delay	12
3.1.7 Frequency saturation	12
3.1.8 Key beeps	12
3.2 Installing and programming accessories	13
3.2.1 Detector learning	13
3.2.2 Deleting detectors	13
3.2.3 Remote control learning	14
3.2.4 Deleting remote controls	14
3.2.5 Remote keypad learning	14
3.2.6 Deleting the remote keypad	14
3.2.7 Deleting all accessories	14
3.3 Programming the phone transmitter	15
3.3.1 Programming the alert message	15
3.3.2 Programming phone numbers	15
3.3.3 Deleting phone numbers	15
4. ALARM STATION OPERATION	16
4.1 Arming the system	16
4.1.1 Total arming (area 1 and 2 active)	16
4.1.2 Partial arming (area 1 active and area 2 inactive)	16
4.2 Disarming the system	16
4.3 Chime mode	17
4.4 Test mode	17
5. FUNCTION SUMMARY TABLE	18
6. ACCESSORY INSTALLATION AND OPERATION	19
6.1 Remote control HA700R	19
6.2 Passive infrared movement detector (PIR) SA68P	19
6.3 Door/window (magnetic) opening detector SA68M	22
7. RESETTING THE STATION	24
8. SPECIFICATIONS	25
9. DECLARATION OF CONFIRMITY	25
10. PRODUCT GUARANTEE	26
11. DISPOSAL	26
12. MAINTENANCE	26
13. SAFETY	26

INTRODUCTION AND GENERAL POINTS

CONGRATULATIONS, you have just made a great step to protect yourself, your home and its content and against assault and theft. Of course an alarm system does not constitute an absolute guarantee against these wrongdoings, but it is sufficiently deterrent.

PRE-PROGRAMMING

The accessories of the HA700+ were **preprogrammed** in the factory to a standard configuration that reduces the installation time to the bare minimum.

Indeed, you only have to:

- Install the batteries in the detectors and the remote control
- Attach all the items to the wall
- Install the batteries, attach the station and connect it to your telephone socket (see page 9).
- Program your message and the telephone call numbers (see page 15)

SYSTEM OPERATION WITH THE PREPROGRAMMED CONFIGURATION

Detector configuration:

- magnetic detector SA68M : programmed in Area 1
- movement detector SA68M : programmed in Area 2

Station in total arming mode

This mode is used only when none is in your home.

In this arming mode, all detectors will trigger the system.

Station in partial arming mode

This mode is used when you are at home.

In this arming mode, only the magnetic detector will trigger the system whereas the movement detector will be inoperative.

IMPORTANT

If the defined parameters do not match your needs, or if you have to install additional accessories, please go to section ACCESSORY LEARNING in order to learn or modify the relevant detector(s).

INTRODUCTION

We strongly recommend to read this guide carefully before to start any installation, and to follow the installation instructions in order, with the items on a table (if you add or modify accessories).

The alarm system HA700+ was designed according to the following principles:

Easy installation:

Anyone can install the system. It does not require any special knowledge in the alarm field. No need of special tools.

Easy use:

The system is armed (totally or partially) and disarmed via a remote control by the touch of a button.

Flexibility:

The system HA700+ can be adapted to your needs.

Thanks to its built-in phone transmitter, you will be notified in case of an intrusion attempt.

It offers the capacity to enable one or several detectors matching to one unoccupied space protection area (garage, first floor, office, garden shed, etc.) when you are present in your home.

Easy to transfer if you move home:

If needed, the system can be easily dismantled and then installed in your new home.

Self supply:

As all the system items are battery-operated, the system can be installed in rooms where a 220 V supply is not available.

Reliability:

All items of the system HA700+ undergo strict quality checks aiming to ensure your home security for long years. Each item works on an approved frequency (868.35 MHz) regulated by European standards



R&TTE
APPROVED
868.35MHz

(CE + RTTE), perfectly safe (coding fixed in factory on more than 268 million possibilities), which do not pose any risk of interference or disturbance for yourself or your neighbours.

1. PACKAGE CONTENT HA700+

The initial alarm kit should contain the following items:

- 1 x Station HA700C



- 1 x Wireless movement detector (PIR) SA68P



- 1 x Wireless door/window (magnetic) detector SA68M



- 1 x Remote control HA700R



Also included:

- Installation & operation manual
- Securing kit
- 4x 1.5V (LR20) batteries (HA700)
- 1x 3.6V Lithium battery (SA68P)
- 1x 3.6V Lithium battery (SA68M)
- 1x 3V CR2032 Lithium (HA700R)

IMPORTANT

Please check that all the mentioned items are included in the package.

2. INSTALLATION PLANNING

Due to a total absence of cable works, a wireless alarm system is very easy to install.

It can be changed easily, because it is simple to transfer a detector to a more efficient place if needed.

This way, you do not have to worry about realizing a perfect installation from the start.

Before to proceed to any installation, it is essential to asses carefully the intrusion risks for your home plan, and specifically its openings to the outside. This will allow you to define the best locations and the amount of infrared or magnetic detectors, and the need to install a remote siren, etc.

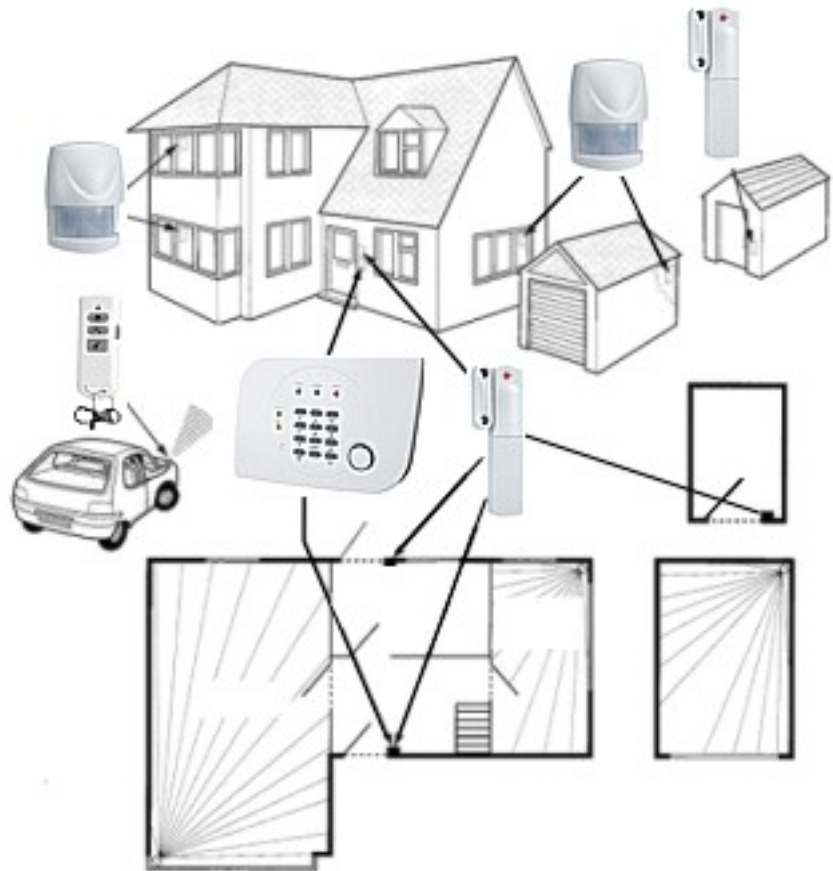

Although the HA700+ allows to manage up to 20 accessories (10 per area), remember that all rooms do not require protection: It is advisable to protect the main exits or those by which an intrusion is most likely, as well as the rooms by which passage is mandatory (hall, access lobby) and those where are located the most precious objects.

Every home has its own layout, and the above drawing is given only as an indication.

An opening magnetic detector SA68M protects the window and the entrance door.

We have protected the living room where are located the sound system, the television, the video recorder, etc. with an infrared detector SA68P as well as the bedroom and the garage.

The alarm station was placed in the lobby. It should be generally installed in a central place of the home, not visible from the windows.

IMPORTANT NOTE BEFORE INSTALLING

This section gathers significant information about the system operation or its accessories.

ADVICE BEFORE INSTALLING

1. The kit accessories are already programmed in the station BUT extra accessories must be learned by the station so they can dialogue with it.
2. The accessories have an initialization delay, it is therefore imperative that to insert the batteries in each accessory 5 to 10 minutes before to start programming or tests.
3. To learn more easily new accessories, arrange all items to be programmed on a table in front of you, before mounting at the planned location.

SYSTEM OPERATION

1. When movement detectors are installed (cover closed), they have a battery saving system which disables the detector for about 1 minute after each detection and the indicator diode remains switched off. In this way, continuous motions in front of a PIR do not use the batteries.
Therefore when you test the system in normal mode, you need to wait two minutes before you pass
2. The battery life calculation is theoretical, the average detector consuming can vary, and tests and installation phases consume batteries significantly.
Hence, the first set of batteries does not last as long as the indicated life. The life of new batteries should be longer because there will not be a programming phase nor any test to be done. The 2 year life is therefore given as an indication and it may vary depending on several parameters (realized test, passing frequency in front of PIR detectors, number of door/window openings, etc.).
3. The microswitches in the magnetic detector must not be altered, unless you use an external contact (see page 24).

TELEPHONE TRANSMITTER AND UNBUNDLING

1. The station phone transmitter behaves as a traditional telephone set, thus it can call landline numbers as well as mobile phone numbers.
When you get in full or partial unbundling, the Internet service provider allows you to connect a traditional phone directly on their BOX. If you choose to do so, you can connect the phone transmitter to make it work properly.
2. Note that in some rare cases, connecting a phone transmitter on a BOX can cause a synchronization loss, hence an operation problem.
If you face this kind of issue, you just have to replace the pull-out filter (supplied by your Internet service provider) by a master filter (it is a filter with an enhanced filtration capacity), which will address the synchronization loss issue.
3. If a phone is already connected to the BOX phone outlet, you have to buy a Y with 1 inlet and 2 outlets (1 for the phone and the other one for the transmitter).

3. INSTALLING AND PROGRAMMING THE STATION

3.1 Installing and programming the alarm station

3.1.1 System description

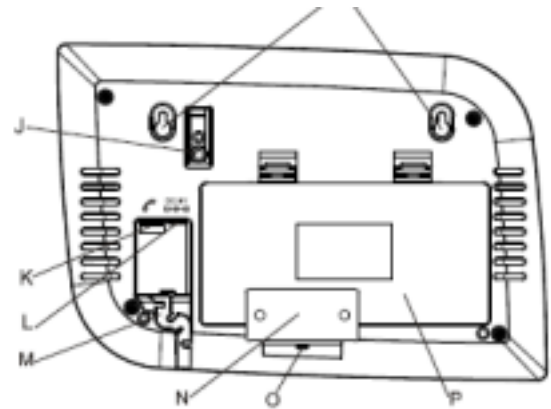
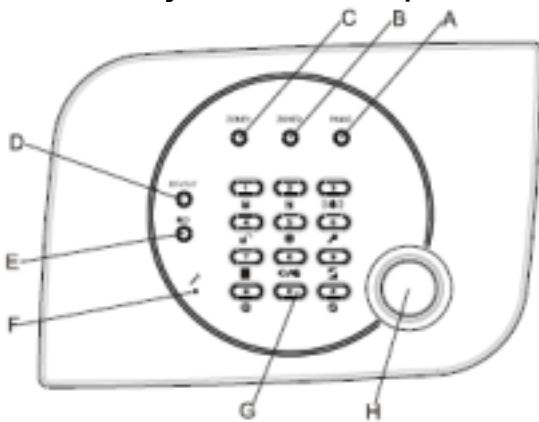

A. Panic LED	G. Keyboard	L. Mains adapter (not included)
B. Area 2 LED	H. Speaker (100dB)	M. Cable tray
C. Area 1 LED	I. Fixing slots	N. Metal mounting bracket
D. STATUS LED	J. Self-protection	O. Fixing screw
E. Low battery LED	K. Telephone socket	P. Battery cover
F. Microphone		

		LED				
	SOUND	Status		Area 1	Area 2	Panic
Battery installation	Long beep	Turns on for 3 seconds				
Frequency saturation	Alarm	Flashes 3 times every 3 seconds				*1,*5
Triggering of the alarm	Alarm			*1, *2, *4, *5		
Triggering of the self-protection	Alarm			*1,*2,*5		
Panic Area or station self-protection	Alarm					*1,*5
Low battery on accessories	Beep		Once per second *3			
Low battery on the station	Beep		3 times per second *3			

*1: During the alarm, the LED flashes one per second.

*2: The LED flashes depending on the area corresponding to the triggering.

*3: The low battery LED turns off when the system is in test mode.

*4: In chime mode, the station emits a "ding-dong".

*5: Triggering of the alarm occurs only when the station is armed whereas triggering in panic area or by the self-protections occurs in any station mode (except in test mode).

3.1.2 Installing the system

LOCATION OF THE STATION

The following aspects are to be considered when selecting a mounting location for the station:

- Check that an intruder willing to reach the station is forced to use an exit protected by a magnetic detector or must walk in front of an infrared detector.
- The station must be mounted near a telephone socket or the BOX.
- The station must be placed out of sight of potential intruders and in a safe location, which can be easily accessed for maintaining the system.
- In order to eliminate the risk of electromagnetic disturbances, do not place the station at a distance of less than 1 meter from big objects or metallic devices, refrigerators, washing machines, high-voltage wires, electric boards, etc.
- In order to ensure the best possible reception, the mounting height above the ground should be at least of 1.5 m.
- The station must be mounted on a solid flat surface to ensure the optimum closing of the self-protection switch on the rear side. It must be mounted at a height of 1.5 to 2 m at a place which is visible daily.
- It is recommended to place the station in such a way that the signal emitted during the entry/exit can be heard from outside the building.

Note: It is important to keep the station out of reach of young children.

MOUNTING THE STATION

1. Use the template at the end of this manual to mark hole positions on the wall. Drill 4 holes of 6 mm
2. Attach the metal plate on the 2 lower holes, allowing the upper screws protrude 5-6 mm.

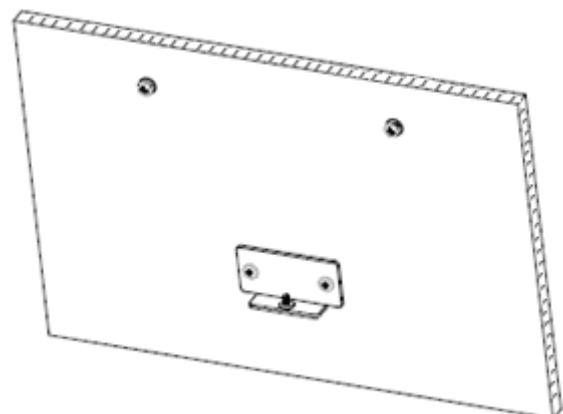
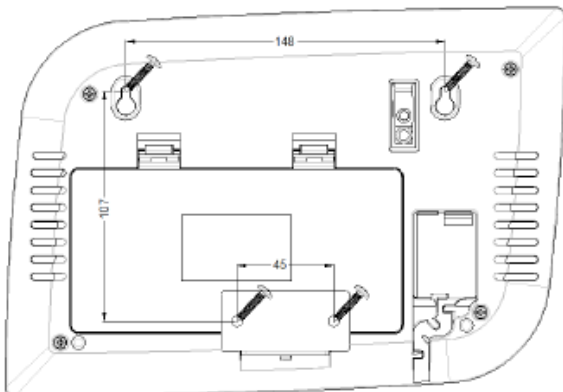

3. Open the compartment at the rear panel of HA700.

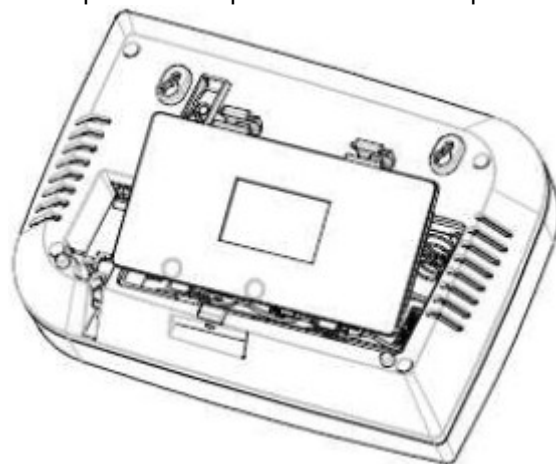
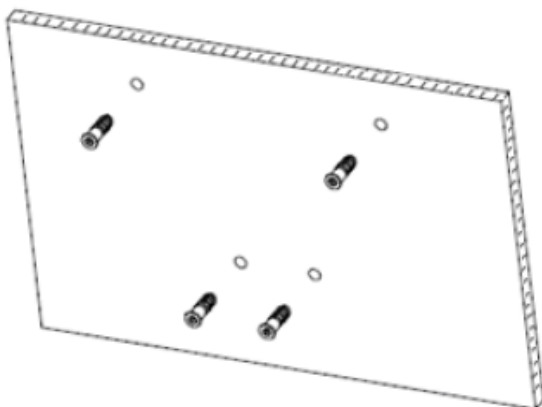

4. Insert the 4 LR20 alkaline batteries.

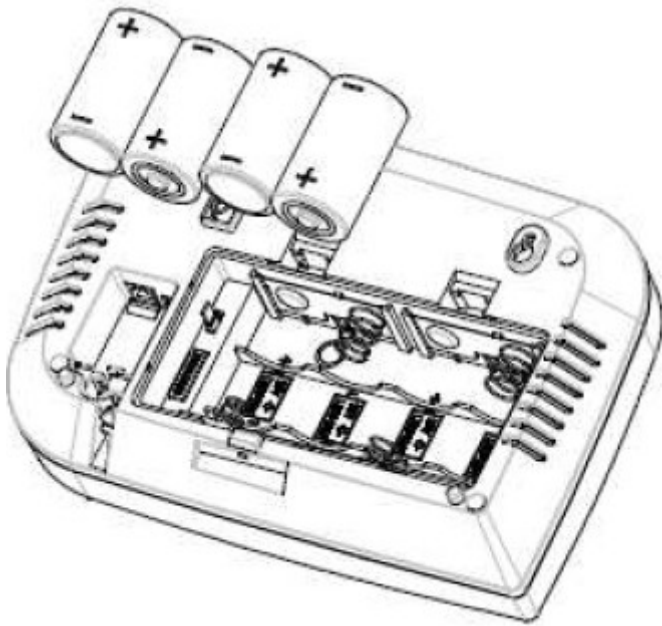

and fix it there to the metal bracket using the screw.

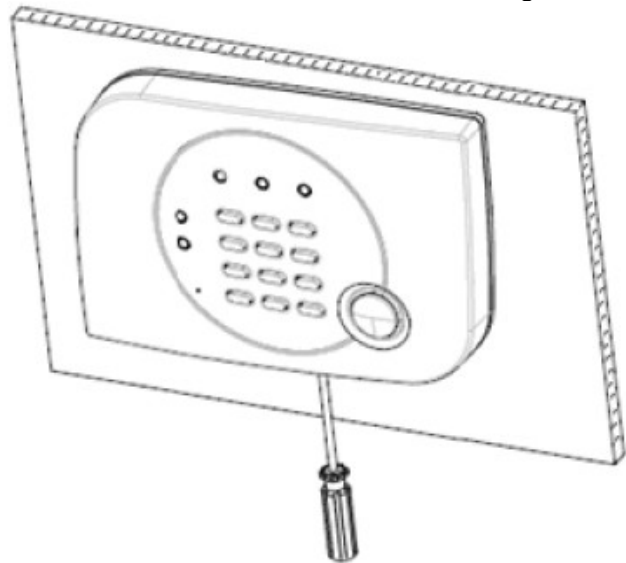

5. Close the compartment at the rear panel of HA700.

6. Connect the telephone cable

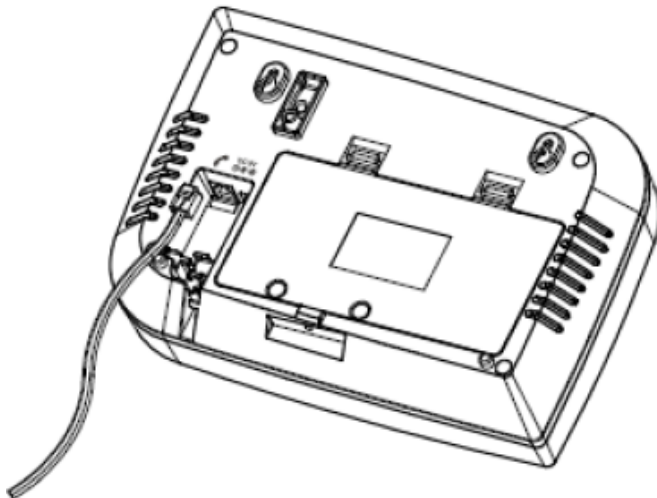

7. Mount the alarm station at this place.

Your alarm system is now ready

CHANGING THE STATION BATTERIES

When the station batteries need to be changed, the station will emit a beep every 30 seconds and the yellow LED  will flash.

To change the batteries:

- Switch the station to test mode (see page 18).
- Dismount the station from its location and open the compartment at the rear panel of HA700+.
- Change the batteries.
- Now close the compartment at the rear panel of HA700+ and mount back the station at its location.
- Exit the mode test (see page 18).

Programming the station

3.1.3 Programming the personal code

A personal code must be saved first by using the alarm station keys. You must choose this code, it will be used to enable or disable the system. To change the code:

- Enter the factory code **1234**.
- Then push the key **6**, a long beep will be emitted and the STATUS LED will flash.
- Enter your 4 digit personal code.
- Push the key **6** to confirm the code change, a long beep will be emitted to confirm that the code has changed.

To modify your code again, repeat the previous instructions, but replace the factory code by your personal code.

3.1.4 Setting the trigger mode

The station allows you to choose between 2 triggering modes in the case of an alarm.

Mode #1: Siren + transmitter Enter **1234** (or your personal code), followed by **0** and then **1**.

In this mode, in the case of an alarm, the station rings and the transmitter will call the programmed numbers (for programming the built-in transmitter, go to page 15).

Mode #2: Silent mode/transmitter alone

Enter **1234** (or your personal code), followed by **0** and then **2**.

In this mode, in the case of an alarm, the station **will not ring**, but the transmitter will call the programmed numbers (for programming the built-in transmitter, go to page 15).

NOTE: Mode 1 is default mode.

3.1.5 Entry delay

This mode allows selecting if the station integrates a 15 seconds entry delay, between detection and the alarm triggering.

To enable/disable the entry delay:

- Enter the factory code **1234** (or your personal code).
- Then push the keys **0** and then **6**, a long beep will be emitted and the STATUS LED will flash.
- Push the key **1** to enable OR the key **2** to disable the entry delay, a confirmation beep will be emitted.

The exit delay is fixed to 15 seconds and cannot be modified.

NOTE: The entry delay is disabled by default.

3.1.6 Alarm delay

It is about the working time of the built-in siren when an alarm is triggered. The delay can be set on 1, 2 or 3 minutes.

To change the alarm delay:

- Enter the factory code **1234** (or your personal code).
- Then push the keys **0** and then **4**, a long beep will be emitted and the STATUS LED will flash.
- Choose the alarm delay.
- Push the key **1** for 1 minute OR the key **2** for 2 minutes OR the key **3** for 3 minutes, one confirmation beep will be emitted.

NOTE: The alarm delay is 1 minute by default.

3.1.7 Frequency saturation

The station has a radio interference detection device on its frequency, for interferences likely to disturb connections with its accessories.

To enable/disable the function:

- Enter the factory code **1234** (or your personal code).
- Then push the keys **0** and then **5**, a long beep will be emitted and the STATUS LED will flash.
- Push the key **1** to enable OR the key **2** to disable the function, a confirmation beep will be emitted.

NOTE: The frequency saturation function is disabled by default.

3.1.8 Key beeps

You can disable the station key beeps by typing **1234** (or your personal code), followed by **8**.

To reactivate beeps, you just have to follow the same procedure.

NOTE: The key beep function is enabled by default.

3.2 Installing and programming accessories

3.2.1 Detector learning

TABLE: DETECTOR OPERATION DEPENDING ON THE STATION ARMING MODES

STATION ARMING MODE PARAMETERS	TOTAL ARMING	PARTIAL ARMING	DISARMING
AREA 1*	DETECTOR ACTIVE		DETECTOR INACTIVE
AREA 2*	DETECTOR ACTIVE	DETECTOR INACTIVE	
PANIC *	DETECTOR ACTIVE		

* 10 detectors maximum per area

To program a detector:

- Enter 1234 (or your personal code), followed by *, a long beep will be emitted and the STATUS LED will flash.
- Push the learning button of the accessory to be added (see adjacent drawing). When the signal is received, a long beep will be emitted and the Area 1, 2 and PANIC LEDs will flash successively.
- Select the detector area. Push key 1 for area 1, key 2 for area 2 and key 3 for PANIC area, a long beep will be emitted.

Note: If an accessory is not properly detected by the station, then the station will exit the learning mode after 30 seconds and you will have to start again the procedure.

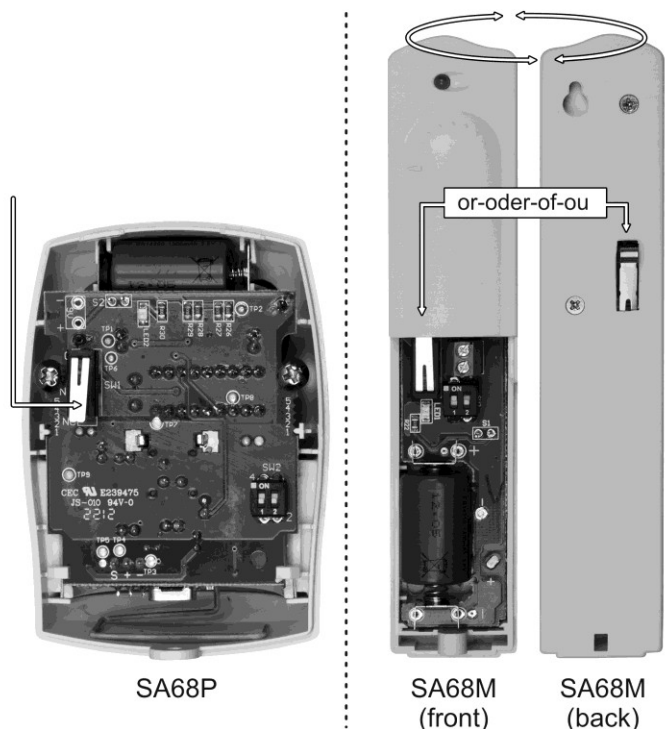

3.2.2 Deleting detectors

The station cannot delete independently every accessory. If you want to delete an accessory, you must also delete all items present in the same area. This means that you must reprogram the other accessories of the deleted area.

To delete an area:

- Enter **1234** (or your personal code), followed by #, a long beep will be emitted and the STATUS LED will flash.
- Enter again **1234** (or your personal code) and select the area to be deleted. Push key 1 for area 1, key 2 for area 2 and key 3 for PANIC area, a long beep will be emitted.

3.2.3 Remote control learning

To program a remote control:

- Enter **1234** (or your personal code), followed by *, a long beep will be emitted and the STATUS LED will flash.
- Push the remote control disarming button. When the signal is received, a long beep will be emitted.

Note: You can learn at most 4 remote controls.



3.2.4 Deleting remote controls

The station cannot erase each remote control individually. If you want to erase a remote control, you must erase all remote controls. This means that you must reprogram each remote control after resetting the memory.

To erase all remote controls:

- Enter **1234** (or your personal code), followed by #, a long beep will be emitted and the STATUS LED will flash.
- Enter again **1234** (or your personal code), followed by 4, a long beep will be emitted.

3.2.5 Remote keypad learning

To program the keyboard:

- Enter **1234** (or your personal code), followed by *, a long beep will be emitted and the STATUS LED will flash.
- Push the self-protection key on the keyboard. When the signal is received, a long beep will be emitted.

Note: Only one remote keyboard can be learned.

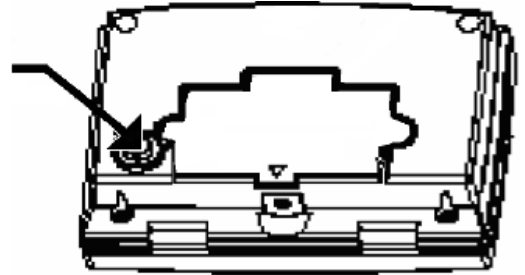

3.2.6 Deleting the remote keypad

To delete the remote keypad:

- Enter **1234** (or your personal code), followed by #, a long beep will be emitted and the STATUS LED will flash.
- Enter again **1234** (or your personal code), followed by 5, a long beep will be emitted.

3.2.7 Deleting all accessories

You can delete all accessories saved in the station without to affect other programs.

To delete all accessories:

- Enter **1234** (or your personal code), followed by #, a long beep will be emitted and the STATUS LED will flash.
- Enter again **1234** (or your personal code), followed by 0, a long beep will be emitted.

3.3 Programming the phone transmitter

3.3.1 Programming the alert message

During a call, the station delivers a message that you must record beforehand. The message maximum duration is 6 seconds.

To record the message:

- Enter **1234** (or your personal code), followed by **5**, the STATUS LED will flash.
- Stand 20-30 cm from the station and record your message.
- If your message lasts less than 6 seconds, push the key * to stop the recording.

To modify your message, just record a new message, which will replace the old one.

3.3.2 Programming phone numbers

You can save up to 4 phone numbers, which will be called one after the other, in the saving order, in the case of an alarm.

To save the phone numbers:

- Enter **1234** (or your personal code), followed by **7**, the STATUS LED will flash.
- Enter the correspondent phone number.
- End with *
- Follow the same procedure for the other numbers.

If you do not enter any number, the station will exit the programming mode automatically after 30 seconds.

3.3.3 Deleting phone numbers

The station cannot erase each number individually. If you want to erase a number, you must erase all of them. This means that you must reprogram the phone numbers after resetting the memory.

To delete all phone numbers:

- In the station, enter **1234** (or your personal code), followed by **9**, the STATUS LED will flash.
- Enter again **1234** (or your personal code), followed by **9**, a long beep will be emitted to confirm the phone number suppression.

The station exits the suppression mode automatically after 15 seconds or if you type **1234** (or your personal code), followed by **4**.

4. ALARM STATION OPERATION

4.1 Arming the system

During the system arming, whatever will be the chosen mode, there will be an exit delay of 15 seconds. The first 10 seconds will be silent, then there will be 1 beep every second, followed by a long beep at the end of the delay to confirm arming.

The system has a total arming mode and a partial arming mode.

TOTAL ARMING: allows activation of all detectors

PARTIAL ARMING: enables only the detectors of area 1

Example:

The system can be configured in such a way that at night you arm only the lower floor detectors as well as the entrance door and the garage, without to put into surveillance the upper floor detectors, so that you can move freely without to trigger the alarm.

4.1.1 Total arming (area 1 and 2 active)

On the station:

- Enter **1234** (or your personal code), followed by **1**.

On the remote control:

- Push the key 

On the remote keyboard:

- Enter **1234** (or your personal code), followed by .

4.1.2 Partial arming (area 1 active and area 2 inactive)

On the station:

- Enter **1234** (or your personal code), followed by **2**.

On the remote control:

- Push the key 

On the remote keyboard:

- Enter **1234** (or your personal code), followed by .

4.2 Disarming the system

On the station:

- Enter **1234** (or your personal code), followed by **4**.

On the remote control:

- Push the key 

On the remote keyboard:

- Enter **1234** (or your personal code), followed by  .

4.3 Chime mode

You can set the station into chime mode. In this mode, it will emit a "ding-dong" when you pass in front of a movement detector or when you open a door/window equipped with a magnetic detector.

CAUTION: In this mode the self-protections and the detectors saved in panic area will always be active and will trigger the station.

To set the station into chime mode:

- Enter **1234** (or your personal code), followed by **3**.

4.4 Test mode

The station can be set in test mode in order to test the system or to operate on an accessory (e.g.: change a battery) without to trigger the system (station, siren and/or transmitter).

To set the station into test mode:

- Enter **1234** (or your personal code), followed by **03**, the STATUS LED will light up once and a beep will be emitted to confirm that the station is in test mode.

Accessory test

When the station is in test mode, actuate every system detector by walking in a protected area or by opening a protected door/window. Every time a detector is activated, the station emits a beep to indicate that a signal has been received.

You can also test the self-protection of every detector by opening its casing. At each activation of a self-protection, the station emits a beep.

To test the remote control, just push each of its keys. Each time these keys are pressed, the station emits a beep.

Phone transmitter test

You can test the station phone transmitter to check that, for example, there is no connecting error.

To test the transmitter, push the key **9** for 3 seconds. Then the station will call the first number saved in its memory. If you want to test all numbers, you have to simulate a real triggering and let the station ring without to stop it. To do this test, you can set the station in silent mode (see page 11).

To exit the station from test mode:

- Push the key *****, the STATUS LED will light up once and a beep will be emitted to confirm that the station have left test mode.

NOTE: The station will exit test mode automatically after 10 minutes.

5. FUNCTION SUMMARY TABLE

Procedure on the station	Function	Function description
1 2 3 4 + 0 1	Triggering mode #1	The station rings and the transmitter will call the programmed numbers.
1 2 3 4 + 0 2	Triggering mode #2	The station does not ring and the transmitter will call the programmed numbers.
1 2 3 4 + 0 3	Test mode	The station emits a "ding-dong" upon receipt of a detection or self-protection signal.
	Push 8 for 3 s.	Enables/disables the exterior siren
	Push 9 for 3 s.	Calls the first phone number.
1 2 3 4 + 0 4	Alarm duration	Determines the alarm duration. 1 or 3 minutes
1 2 3 4 + 0 5	Frequency saturation	Detects radio interferences.
1 2 3 4 + 0 6	Entry delay	Determines the entry delay. 0 or 15 s
1 2 3 4 + 1	Total arming	Arms the whole system (Area 1 + Area 2)
1 2 3 4 + 2	Partial arming	Arms part of the system (Area 1)
1 2 3 4 + 3	Chime mode	The station emits a chime in case of detection.
1 2 3 4 + 4	Disarming	Disables the station.
1 2 3 4 + 5	Alert message	Saves the alert message (max 6 seconds)
1 2 3 4 + 6	Personal code	Modifies the personal code.
1 2 3 4 + 7	Programming phone numbers	Registering telephone numbers to call in case of an alarm.
1 2 3 4 + 8	Key beeps	Enables or disables a beep when keys are pressed.
1 2 3 4 + 9	Suppressing phone numbers	Deletes all the phone number saved in the station.
1 2 3 4 + *	Programming accessories	To program accessories.
1 2 3 4 + #	Deleting accessories	Deletes accessories.

NOTE: Code 1234 is default code. If you have set a personal code, then you have to use this code.

6. ACCESSORY INSTALLATION AND OPERATION

6.1 Remote control HA700R

The remote control allows you to activate several functions of your station (Disarming, Total Arming, Partial Arming, Panic and Test Mode).

The remote control has a Panic switch, that when actuated causes immediately a complete alarm situation if the system is in Armed or Disarmed mode (except if the system is in Test mode).

The remote control uses one CR2032 Lithium battery, which, in normal conditions, has a lifespan of more than 2 years. If the battery is in good condition, the remote control LED turns on constantly when a key is pressed.

However, if the battery is low, the LED will flash when a key is pressed. In this case, replace the battery as soon as possible.

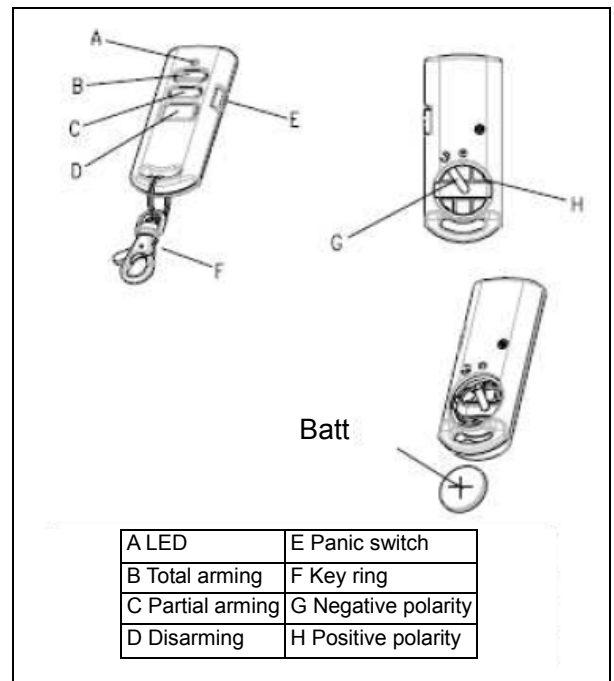

INSTALLING OR CHANGING THE BATTERY

- Using a coin, unscrew and remove the rear cover.
- If you change the battery, replace the old one.
- Insert the battery so that the side with the + mark is visible (not the printed circuit side).
- Close the cover.

IMPORTANT: If you lose a remote control, you have to delete all remote controls saved in the station memory (following the indications on page 14), then learn again the remote controls that you have.

6.2 Passive infrared movement detector (PIR) SA68P

PIR detectors are designed to detect movement in a protected area by detecting changes in infra-red radiation levels caused when a person moves within or across the device's field of vision. If movement is detected an alarm signal will be emitted, (if the system is armed and the alarm zone active).

Note: PIR detectors will also detect animals, so ensure that pets are not permitted access to areas fitted with Passive Infra-Red Detectors when the system is armed.

The PIR Detector adopts a 3.6V 1200mAh Lithium battery which under normal conditions will have typical life in excess of 4 years. When the battery level drops, with the PIR in normal mode and the battery cover fitted, the LED behind the detection window will flash upon detecting movement. When this occurs the batteries should be replaced as soon as possible.

CHOOSING A MOUNTING LOCATION

The PIR Detector is suitable for mounting in dry interior locations only.

The recommended position for a PIR Detector is in the corner of a room mounted at a height between 1.8 and 2m. At this height, the detector will have a maximum range of up to 10m with a field of view of 110°, subject to the position for the PCB being set in 5. The position of the PCB inside the PIR can be set to 5 different positions to adjust the range of the detector. Setting the PCB in position 3 will reduce the range to

7m approximately, with position 1 providing a range of 5m approximately. The recommended position setting for the PCB is in position 5.

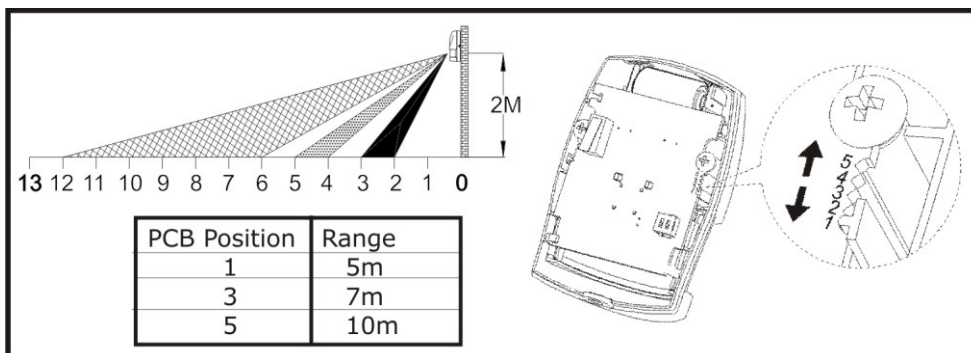

When considering and deciding upon the mounting position for the detector the following points should be considered to ensure trouble free operation:

1. Do not locate the detector facing a window or where it is exposed to or facing direct sunlight. PIR Detectors are not suitable for use in conservatories.
2. Do not locate the detector where it is exposed to ventilators.
3. Do not locate the detector directly above a heat source, (e.g. fire, radiator, boiler, etc).
4. Where possible, mount the detector in the corner of the room so that the logical path of an intruder would cut across the fan detection pattern. PIR detectors respond more effectively to movement across the device than to movement directly towards it.

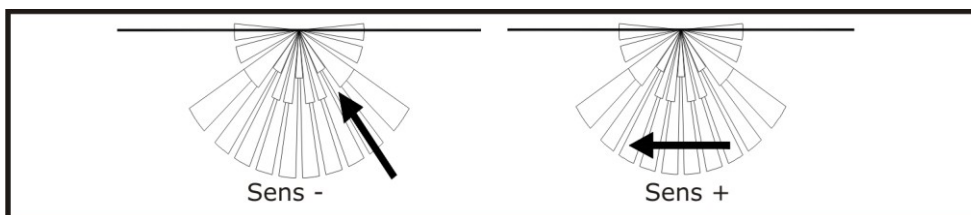

Do not locate the detector in a position where it is subject to excessive vibration.

5. Ensure that the position selected for the PIR detector is within effective range of the system, (refer to System Installation and Operating Manual).

Note: When the system is armed, household pets should not be allowed into an area protected by a PIR detector as their movement would trigger the PIR and generate an alarm.

INSTALLING THE PIR DETECTORS

(Ensure that the system is in Test Mode).

1. Undo and remove the fixing screw from the bottom edge of the PIR. Carefully pull the bottom edge of the detector away from the rear cover and then slide down to release the top clips
2. Carefully drill out the required mountingholes in the rear cover using 3mm drill according to whether the unit is being mounted in a corner or against a flat wall.

Note: Using 1st mounting hole to fulfill corner mounting installation, while 2nd mounting hole for flat wall installation.

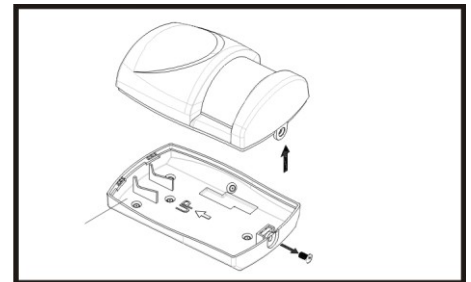

3. Using the rear cover as a template, mark the positions of the fixing holes on the wall.
4. Fix the rear cover to the wall using the two 18mm No.4 screws and 25mm wall plugs, (a 5mm hole will be required for the wall plugs). Do not over-tighten the fixing screws as this may distort or damage the cover.
5. Configure the PIR detector as described below. Remember that on initial installation that the device needs to be tested and should therefore be set in Walk Test Mode.
6. Check that the detector PCB is located and set in the correct position to provide the required detection range. To adjust the PCB position, simply slide it up or down ensuring that the location legs are aligned with the required position number marked on the board.
7. To refit the PIR detector to the rear cover and locate the clips in the top edge into the rear cover. Push the lower edge of the detector into place and refit the fixing screw in the bottom edge of the PIR to secure in position. Do not over-tighten the fixing screws as this may damage the casing.

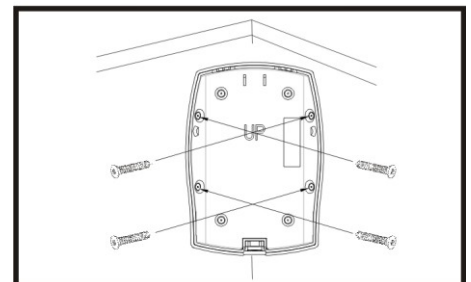
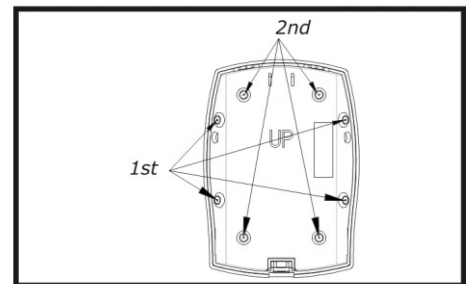

SETTING THE PIR DETECTORS

Located on the PCB of the PIR Detector is a two-position DIP switch (SW2). When conducting the Walk Test, ensure that the DIP switch SW2 is set as follows:

1. DIP1 of SW2 is used to configure the PIR Detector for walk test mode, which allows the operation of the detector to be checked during installation without triggering a Full Alarm.

ON Walk Test mode
OFF Normal mode

SW2	DIP1	DIP2
ON	✓	
OFF		✓

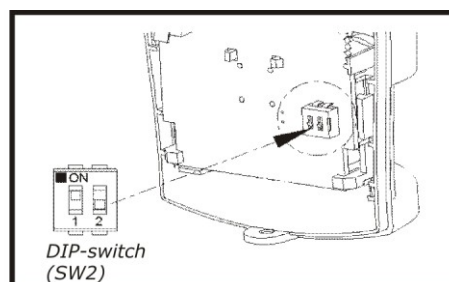

Note: On initial installation the detector should be set into Walk Test mode ready for testing. Upon completion of Walk Test mode, set DIP1 of SW2 to OFF for normal detection mode.

- The PIR Detector incorporates an anti-false alarm feature designed to compensate for situations where the detector may be affected by environmental changes, (e.g. insects, air temperature, etc). This feature is called “sensitivity detection” and may be selected for high or low detection. The recommended setting is for high sensitivity detection. However, in cases of extreme environmental problems or if unattributable false alarms are experienced, it may be necessary to select low sensitivity detection.

Set the required sensitivity detection using DIP2 of SW2 as follows:

- ON high sensitivity detection
- OFF low sensitivity detection

Note: The higher the sensitivity detection the less movement will be necessary before the PIR detector will trigger the alarm.

6.3 Door/window (magnetic) opening detector SA68M

The Magnetic contact consists of two parts; a Detector and a Magnet. They are designed to be fitted to doors or windows with the Magnet mounted on the opening part and the Detector mounted on the fixed frame. Opening the protected door/window will remove the magnetic field, trigger the Detector and generate an alarm condition, (if the system is armed and the alarm zone active).

The Detector is powered by one 3.6V 1200mAh Lithium battery which under normal conditions will have typical life in excess of 5 years. Under normal battery conditions with battery cover fitted the LED on the Detector will not illuminate when the Detector is triggered, (unless in test mode). However, under low battery conditions this LED will be illuminated when the detector is triggered. When this occurs the battery should be replaced as soon as possible.

For double security, there are two tamper switches fitted on the Detector. (FIGURE 2) Either removing the Detector from the protected door/window or removing the battery cover will generate a full alarm condition. The Magnetic Contact Detector is of self-contained wired Magnetic Contact. This contact must be of a normally closed contact type with the contacts being opened in order to generate an alarm condition.

CHOOSING A MOUNTING LOCATION

The Magnetic Contact Detector is suitable for mounting in dry interior locations only. Decide which doors/windows are to be protected by Magnetic Contact Detectors, (usually the front and back doors as a minimum will have Magnetic Contact Detectors fitted). Additional detectors may also be fitted where required to other vulnerable doors or windows, (e.g. garage, patio/conservatory doors etc).

Note: Take care when fixing the Detector to a metal frame, or mounting within 1m of metalwork (i.e. radiators, water pipes, etc) as this could affect the radio range of the device. If required, it may be necessary to space the magnet and detector away from the metal surface using a plastic or wooden spacer to achieve the necessary radio range.

INSTALLING THE MAGNETIC CONTACT DETECTORS

Ensure that the system is in Test Mode.

- Undo and remove the fixing screw from the bottom edge of the Detector. Remove the battery cover by sliding and lifting it off. (DO NOT use a screwdriver to lever the cover off).
- Fit the 3.6V Lithium battery supplied, with the negative (-) towards the battery spring.

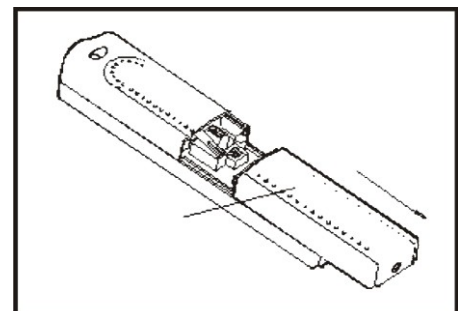

3. Mount the Detector to the fixed part of the frame along the opening edge opposite the hinges using either the double sided adhesive tape or screws provided.

If fixing the Detector with screws; fit the Keyhole slot in the top of the Detector over the head of the smaller pan-head screw. Secure the bottom of the Detector using the 12mm countersunk head screw fitted within the battery compartment. You will need to drill out the centre of the fixing screw hole using a 3mm drill. Do not over tighten the fixing screws as this may distort or damage the casing.

4. Fit the Magnet to the moving part of the door/window opposite the Detector using the adhesive tape or 15mm fixing screws.

Ensure that the parallel gap between the Magnet and Detector is less than 10mm and that the arrow on the Magnet is pointing towards and aligned with the mark on the Detector.

5. If several windows need to be protected, remove the self-contained wired supplied and adopt the wire according to the specifications as mentioned below. This should be wired to the terminal block provided in the battery compartment in series connection. The wired contact should be connected using two core (24AWG) wire of maximum length 1.5m.

A cable entry cut-out is available and adjacent to the terminal block.

6. Refit the battery cover.

SETTING THE MAGNETIC CONTACT DETECTORS

1. Located on the PCB of the Detector is a two-position DIP switch (SW2).
2. DIP switches 1-2 are used to enable/disable the internal or external wired magnetic contact. If setting the DIP1 & DIP2 to 'Off', only the internal contact will be active. When two contacts are in use for internal and external connection simultaneously, one activation will be counted if one of the contacts is opened; while both contacts must be all close, the Detector will then be treated as close.
3. If external contacts are wired to the Detector, set the DIP1 to 'Off' and DIP2 to 'On'.

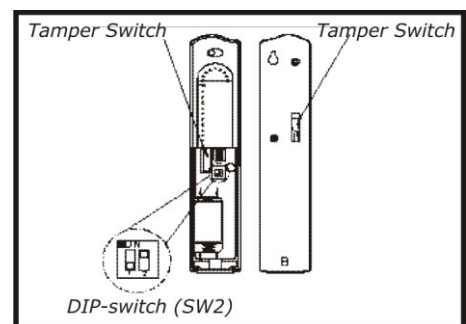

On/Off Selection	DIP1 of SW2	DIP 2 of SW2
ON	Internal on	External on
OFF	Internal off	External off

IMPORTANT: If external contacts are not connected, set the DIP1 to 'On' and DIP2 to 'Off' for the detector to operate correctly.

4. In order to communicate with the Control Panel, the ID code of the Detector needs to be learned by the Control Panel. By pressing the tamper switch either located adjacent to the PCB or rear cover of the Detector will emit the ID code to the Control Panel instantly, subject to the Control Panel being set at the Zone setup mode.

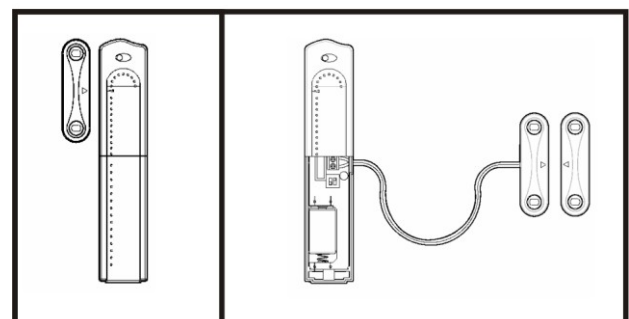

7. RESETTING THE STATION

You can reset the station to delete all accessories, the message, the phone numbers and the personal code.

To reset the station:

- If possible, switch the station to test mode (see page 18).
- Dismount the station from its location and open the compartment at the rear panel of HA700.
- Remove the batteries.
- Move the jumper for reset.



Position to reset the station

- Wait 5 minutes.
- Put the batteries back into place, the station beeps and the STATUS LED lights up for 3 seconds.
- Put the jumper back into its original position.



Default position

- Now close the compartment at the rear panel of HA700.
- Mount back the station at its location.

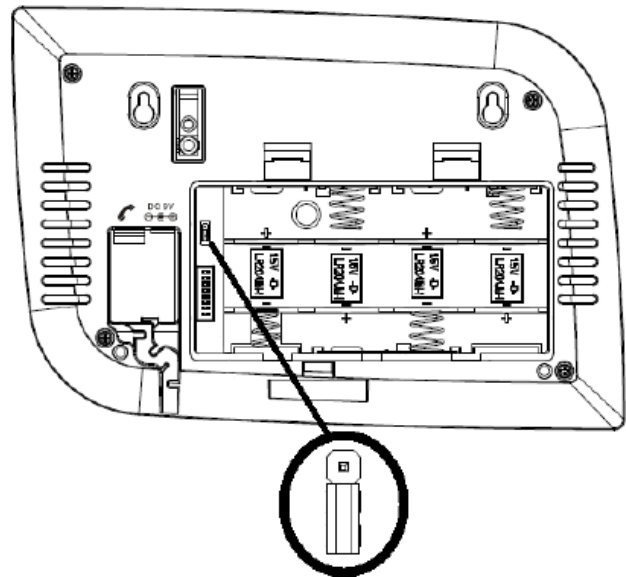

Default setting

Arming mode	Disarmed
Personal code	1 2 3 4
Key beep	Active
Triggering mode	Siren/transmitter both active
Alarm delay	1 minute
Frequency saturation	Disabled
Entry delay of 15 seconds	Disabled

8. SPECIFICATIONS

Common technical characteristics:

Operating frequency : 868.35 MHz in ASK for detectors, remote controls and exterior keyboard.
 Operating temperature : -10°C~ +45°C
 Operating humidity : < 90%
 Operating range : 300m in open field for detectors, remote controls and exterior keyboard.

Station HA700C

- 2 radio areas individually programmable, incorporating up to 10 detectors per area.
- 1 Panic Area (monitoring 24h/24h) for any detector, incorporating up to 10 detectors per area.
- 5 LEDs (Area 1, Area 2, Panic, STATUS and )
- Automatic learning of the radio communication code on the station.
- Programmable entry delay of 0 or 15 seconds.
- Exit delay of 15 seconds
- Programmable alarm duration of 1 minute or 3 minutes.
- TEST mode
- Self-protection at the opening and separation
- Non-volatile memory
- Built-in siren (95dB at 1m)
- Telephone socket (landline)
- Operating with batteries or accumulators (4x 1,5V LR20)

Passive infrared detector PIR SA68P

- Battery : 3,6V1200mAh Lithium
- Frequency : 868 Mhz
- Operating : -10° ~ +50°

Opening magnetic detector SA68M

- Battery : 3,6V1200mAh Lithium
- Frequency : 868 Mhz
- Operating : -10° ~ +50°

Remote control HA700R

- 5 functions: Total Arming, Partial Arming, Disarming, Test Mode and Panic
- Fixed communication code (2exp 28)
- Radio range: 100 m in the open field
- LED (operating and low battery)
- Key ring
- Lithium button cell 3V (CR2032) included
- Frequency: 868 Mhz

9. DECLARATION OF CONFIRMITY

Hereby, Smartwares declares that this equipment is in compliance with the essential requirements and other relevant provisions of Directive 1999/5/EC. For the document of conformity go to www.elro.eu or scan the QR code.



R&TTE
APPROVED
868.35MHZ

smartwares safety & lighting Broekakkerweg 15 5126 BD Gilze The Netherlands WWW.SMARTWARES.EU	NL : 0900-2088888 lokaal tarief	CUSTOMER SERVICE
	BE : 070-233031 lokaal tarief	
	FR : 0825 560 650 15ct/min.	
	DE : +49 (0) 1805 010762 14Ct./Min. dt. Festnetz, Mobil max. 42Ct./Min	
	UK : +44 (0) 845 230 1231 ES : +34 938427589	

Smartwares Safety & Lighting B.V.
 P.O. Box 117 - 5126 ZJ Gilze - The Netherlands
 Broekakkerweg 15 - 5126 BD Gilze - The Netherlands
 T +31 161 455 363
 F +31 161 452 991
 W www.smartwares.eu

Authorized representative: Mr. Ad Netten
 Quality Manager
 Date: 01.02.2013

QR code





10. PRODUCT GUARANTEE

This product has factory warranty according to EU regulations. Guarantee lasts for the number of years shown on the packaging, starting from the date of purchase. Keep the receipt - proof of purchase is required in order to rely on guarantee. In the case of problems, please contact with the store where you purchased the product. For further product information call to our Hotline or visit our website: www.smartwares.eu . You can also register your product there.

11. DISPOSAL

Correct Disposal of This Product (Waste Electrical & Electronic Equipment) (Applicable in the European Union and other European countries with separate collection systems)

 This marking shown on the product or its literature, indicates that it should not be disposed with other household wastes at the end of its working life. To prevent possible harm to the environment or human health from uncontrolled waste disposal, please separate this from other types of wastes and recycle it responsibly to promote the sustainable reuse of material resources. Household users should contact either the retailer where they purchased this product, or their local government office, for details of where and how they can take this item for environmentally safe recycling. Business users should contact their supplier and check the terms and conditions of the purchase contract. This product should not be mixed with other commercial wastes for disposal.

 * **Always throw empty batteries to the battery recycling bin.**
* **If the battery is built-in inside the product, open the product and remove the battery.**

12. MAINTENANCE

 The devices are maintenance-free, so never open them. The guarantee becomes void when you open the appliance. Only clean the outside of the devices with a soft, dry cloth or a brush. Prior to cleaning, remove the devices from all voltage sources. Do not use any carboxylic cleaning agents or petrol, alcohol or similar. These attack the surfaces of the devices. Besides, the vapors are hazardous to your health and explosive. Do not use any sharp edged tools, screw drivers, metal brushes or similar for cleaning. Warning: Protect the battery against fire, too much heat and sunshine

13. SAFETY

- * Make sure that all electric connections and connection cables meet the pertaining regulations and are in conformity with the operating instructions.
- * Do not overload electrical outlets or extension cords, fire or electric shocks can be the result
- * Please contact an expert in case you have any doubts about the mode of operation, the safety or connecting the appliances.
- * Keep all parts away from young children's reach
- * Do not store this item on wet, very cold or warm places, this can damage the electronic circuit boards.
- * Avoid dropping or shocks, this can damage the electronic boards
- * Never replace damaged power cables yourself! In such a case, remove them from the net and take the devices to a workshop.
- * Repairs or opening of this item may only be performed by an authorised workshop.
- * Wireless systems are subject to interference from cordless phones, microwaves, and other wireless devices operating in the 2.4GHz range. Keep the system AT LEAST 10 ft away from the devices during installation and operation.
- * Do not swallow batteries. Keep batteries out of the reach of children.