

Wireless Pan/Tilt APP Camera

Installation and Operating Instructions

Model: C734IP – 10.021.38

Version 1.1

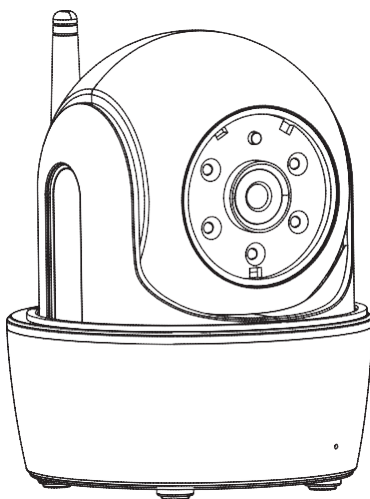

PLEASE READ THESE INSTRUCTIONS CAREFULLY BEFORE USING THIS PRODUCT AND KEEP THIS MANUAL FOR FUTURE REFERENCE.

The state of art WAPP camera is capable of deliver high quality Digital High Defi (HD) video to your smart-mobile device(s), which would require higher internet bandwidth. Due to your local internet environment condition, your mobile device(s) may display black-screen or temporary disconnect to the WAPP camera.

* Make sure the WAPP camera is operating with suffi internet bandwidth, 1Mbps (upload/ download speed) is suggested.

* For best performance, **the smart-mobile device(s) need to be on Wi-Fi or 4G mobile network** in order to receive maximum download speed.

* **When the internet transmission is low**, your WAPP APP will automatically switch to Relay Mode:
· **By adjusting to “Better Streaming” in the system setting section may improve the WAPP APP performance.**

* **Your internet bandwidth is limited.** For best performance, try to avoid more than two users connecting to the WAPP camera simultaneously.

* Make sure your smart-mobile device(s) is equipped with up-to-date technology, **1.5GHZ dual core processor or equivalent is suggested.**

* **If the signal strength of your Wi-Fi router is weak**, there are several ways to improve transmission:

- Change router/camera relative position to receive better signal.
- Use wire Ethernet cable on the WAPP camera to establish connection between WAPP camera and your router.
- Use Wi-Fi repeater/extender to maximize the service range of your Wi-Fi route.
- Switch your router to 11b/11g mode in order to improve router service range.
- Purchase extension cable or high gain antenna for your camera from the WAPP vendor.

* Please make sure the memory card used is **CLASS10** rated.

CONTENTS

INTRODUCTION	2
WIRELESS DEVICES OPERATING RANGE	2
IMPORTANT SAFETY PRECAUTIONS	2
KIT CONTENT	4
SAFETY AND INSTALLATION TIPS	5
NIGHT VISION	6
CAMERA OVERVIEW	7
DOWNLOAD AND SETUP THE APP	8
LIVE VIEW / SNAPSHOT / RECORDING	11
VIEWING YOUR SNAPSHOTS	12
PLAYBACK YOUR VIDEOS	12
MAIN PAGE OVERVIEW	16
ADVANCED SETTING	21
ADMIN PASSWORD	22
EMAIL ALERT	22
TIME ZONE	23
DAYLIGHT SAVING	23
DEVICE SECURITY CODE	23
VIDEO SETTINGS	23
WI-FI SETTING	24
SENSITIVITY SETTING	25
EMAIL SETTING	25
SD CARD SETTING	26
OVERWRITE SD CARD	26
PROFILE SETTING	26
DEVICE INFORMATION	26
TROUBLE SHOOTING	27
PRODUCT SPECIFICATION	30
STORAGE MEDIA MANAGEMENT	31

INTRODUCTION



IMPORTANT SAFETY PRECAUTIONS

Damages caused by non-compliance with this operating manual will void the warranty! We will not assume any liability for damages to items or persons caused by improper handling or non-compliance with the safety notices! Any warranty claim will be null and void in such cases.

1. Do not drop, puncture or disassemble the camera; otherwise the warranty will be voided.
2. Avoid all contact with water, and dry hands before using.
3. Never tug on the power cords. Use the plug to unplug it from the wall outlet.
4. Do not expose the camera to high temperature or leave it in direct sunlight. Doing so may damage the camera or cause camera temporary malfunction.
5. Use the devices with care. Avoid pressing hard on the camera body.
6. For your own safety, avoid using the camera or power off the camera when there is a storm or lightning.
7. Remove the power adapter during long periods between usages.
8. Use only the accessories and power adapters supplied by the manufacturer.
9. To meet the regulations pertaining to parental responsibility, keep the devices out of the reach of infants.
10. Check power cables, do not get crushed or damaged by sharp edges whenever the devices are in operation.





FCC Compliance Statement: This device complies with Part 15 of the FCC rules. Operation is subjected to the following two conditions: (1) this device may not cause harmful interference, and (2) this device must accept any interference received, including interference that may cause undesired operation.



Products with CE Marking comply with EMC Directive (2004/108/EC); Low Voltage Directive (73/23/EEC); R&TTE(1999/5/EC); ROHS Directive (2011/65/EU) issued by the Commission of the European Community. Compliance with these directives implies conformity to the following European Norms: EMC: EN 301 489
LVD: EN 60950
Radio: EN 300 328

FCC/CE WARNING

This equipment has been tested and found to comply with limits for a Class B digital device, pursuant to Part 15 of the FCC rules and ETSI(EN) 300328. These limits are designed to provide reasonable protection against harmful interference in residential installations. This equipment generates, uses, and can radiate radio frequency energy, and if not installed and used in accordance with the instructions, may cause harmful interference to radio communications. However, there is no guarantee that interference will not occur in a particular installation. If this equipment does interference to radio or television equipment reception, which can be determined by turning the equipment off and on, the user is encouraged to try to correct the interference by one or more of the following measures: -Reorient or relocate the receiving antenna.-Move the equipment away from the receiver.-Plug the equipment into an outlet on a circuit different from that to which the receiver is connected.-Consult the dealer or an experienced radio/television technician for additional suggestions. You are cautioned that any change or modifications to the equipment not expressly approved by the party responsible for compliance could void your authority to operate such equipment.

DISPOSAL



If the camera system no longer functions or can no longer be repaired, it must be disposed of according to the valid statutory regulations. Disposal of spent batteries/accumulators:

You are required by law (Battery Ordinance) to return all spent batteries and accumulators. Disposing of spent batteries/accumulators with common household waste is prohibited! Batteries/accumulators that contain hazardous substances are marked with the symbols on the side. These symbols indicate that it is prohibited to dispose of these batteries/accumulators in the household waste. The abbreviations for the respective heavy metals are: Cd=cadmium, Hg=mercury, Pb=lead. You can return spent batteries and accumulators that can no longer be charged to the designated collection points in your community, outlets or wherever batteries or accumulators are sold. Following these instructions will allow you to fulfill the legal requirements and contribute to the protection of our environment!

KIT CONTENT

Wireless App Camera

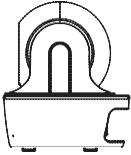

x 1

Ethernet cable

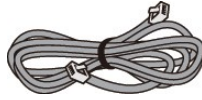

x 1

Camera Antenna



x 1

Power Adapter

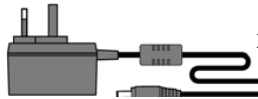

x 1

Screw Pack



x 1

Quick Start Guide

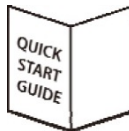

x 1

Tools Required:

- Electric drill
- 5mm masonry drill bit
- 15mm masonry drill bit
- No. 2 Philips screwdriver

For best system performance:

- iOS: iPhone5 / iPad2 / Mini iPad with iOS 7.0 or above.
- Android: 1.5G dual core processor dual core procesor with 1G Ram or above.
- Storage: Class 10 memory card.
- Bandwidth: 1Mbps or above upload/download speed suggested.

SAFETY AND INSTALLATION TIPS

Do not attempt to open the units with the power adaptor plug connected to avoid any risk of personal injury.

When installing CCTV camera(s), always follow manufacturer's advice when using power tools, steps, ladders, etc. and wear suitable protective equipment (e.g. safety goggles) when drilling holes. Before drilling holes through walls, check for hidden electricity cables and water pipes. The use of cable/pipe detector is advisable.

It is also advisable to avoid exposing any cameras to extreme weather conditions (e.g., under a gutter which is prone to any water leaks). When installing any cameras with this unit, it is advisable to use cable conduit to protect any video/power extension cables from being exposed externally and to prevent/reduce the chances of the cables being tampered with. After drilling any hole through an external wall for a cable, ensure the hole is sealed up around the cable using a sealant to prevent drafts.

To prevent a fire or electrical shock hazard, do not attempt to open the housing while the unit is exposed to rain, water or wet conditions. There are no user serviceable parts inside. Refer servicing to qualified service personnel. Avoid pointing the camera(s) directly at the sun or any bushes, tree branches or moving objects that might unnecessarily cause the camera to record.

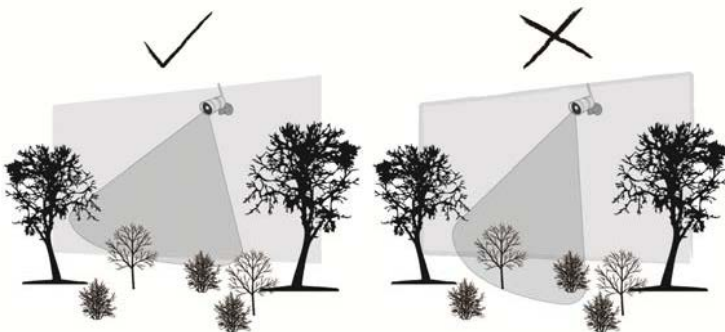

NIGHTVISION

The camera has built-in infrared LEDs to allow you to view at night for 24-hour surveillance. The LEDs will automatically activate at night and the picture viewed will turn to black and white. The night viewing range is up to 5 meters.

CAMERA OVERVIEW

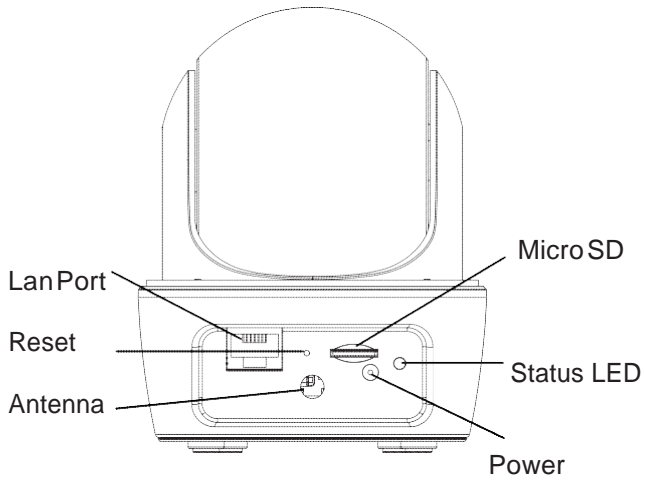
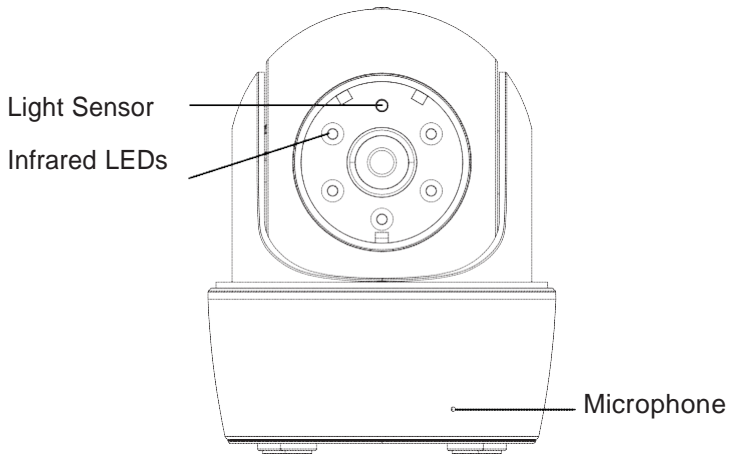

DOWNLOAD AND SETUP THE APP

The Wireless APP camera is designed to deliver live video footage directly to your smart phone or tablet device. Please follow these steps to download, setup and use the APP.



APP Name: OMGuard HD

Download the App

1. From your smart phone or tablet device, click the APP Store/Google Play and search for "OMGuard HD".
2. Once located the APP, select download.
3. Once download completed, you will find the APP icon on your mobile device screen.

APP Setup

⚠ BEFORE YOU START

- Before connecting the camera to power source, first connect the camera to your Wi-Fi router by using only the Ethernet cable provided.
- After the camera is connected to the Wi-Fi router, connect the camera to power source and wait until GREEN LED begin flashing. DO NOT begin the setup process until wait until GREEN LED begin flashing. LEDs become steady on (roughly 45 seconds).
- Please follow the steps in the following pages to complete the setup

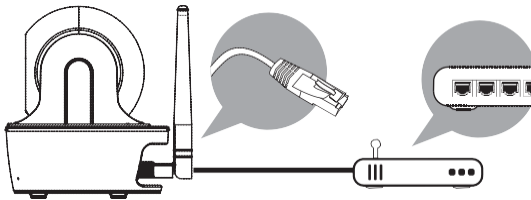

APP Setup

1. Make sure the mobile device you are using is connected to the same Wi-Fi router the camera is connected to.
2. Locate the “OMGuard HD” icon in your mobile device and launch the App.



3. Tap the ADD CAMERA icon to add a new camera. Then click the SEARCH button for a quick setup. The APP will search available camera(s) connecting to the Wi-Fi router and display the camera information in the pop up list. Select the camera from the list and the APP will automatically add the camera’s DID code to the DID column. Enter the default password 123456.

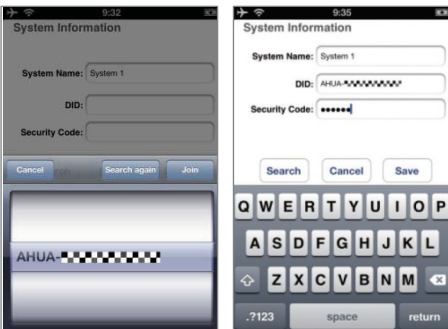

(iOS)

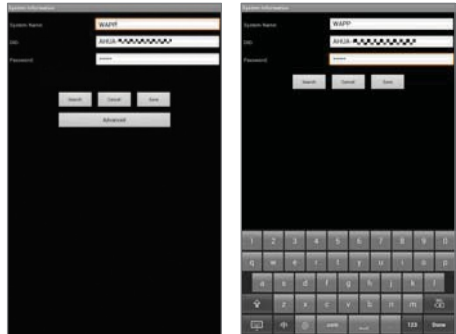

(Android)

Note:

After you have entered the default password, the APP will remind you to change the default password.

4. Click SAVE to complete the camera settings. The system confirms the user identity and grants permission to user access.
5. You can refer to "ADD CAMERA" section for detail on adding additional camera(s).

In most cases, you can successfully add the camera according to the steps above. However, the camera will not find the network if Wi-Fi router turns off the SSID broadcasting function. Please enable the SSID broadcasting to complete the settings.



LIVE VIEW / SNAPSHOT / RECORDING



Tap to take snapshot image(s) of the video. The captured snapshots will be stored in your mobile device.



Tap to turn ON/OFF the volume.



Tap to Start/Stop recording. The recorded video file will be stored in the memory card of your camera.



Tap to set/move camera to default position



Tap and hold the icon to send the voice to remote device (Push To Talk)



Tap to return to the main page.

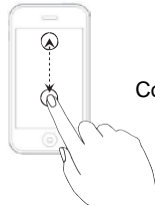
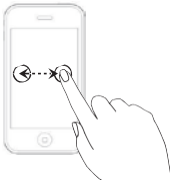
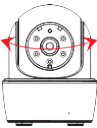

Control camera direction via finger swipe.

The APP allows users to have access to live video. User can take snapshot image(s) and record the live video.

When you launch the App on the smart phone or tablet, the image displaying on the main screen is the very last automatically captured snapshot from the live view of the previous established session. Tap the image to enter live view mode.

The controls and layout of the APP have been customized to meet the operating system requirements of the mobile device. The main page may vary, depending on your mobile device. By default, the live view is displayed in portrait mode. You can also turn the device sideways to switch to landscape mode for a larger view.

VIEWING YOUR SNAPSHOTS

For iOS

You snapshots will be named with the time stamp and saved into the Camera Roll location of your mobile device.

For Android

You snapshots will be named with the time stamp and saved into the **Photo Gallery > snapshot** folder on your mobile device.

PLAYBACK YOUR VIDEOS

The recorded video file(s) on your camera is automatically saved to the memory card inserted in your camera. You can remotely access the file(s) for playback via your mobile device.



Tap the CAMERA SETTING icon on the main page.



(iOS)



(Android)



Tap EVENT LIST icon and the Date-Time filter would appear. User may define the period for system to display all available recorded file(s) for playback.

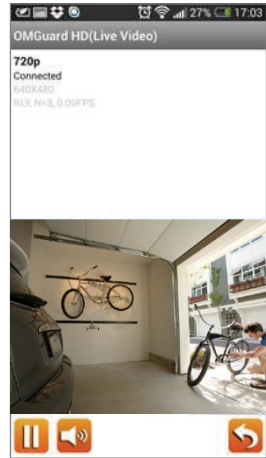
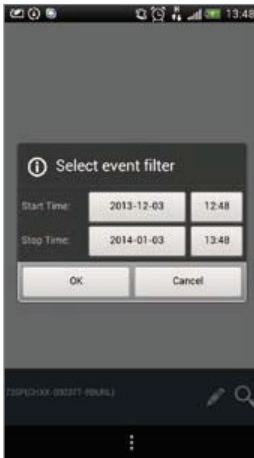

During the playback, you can tap the PAUSE icon to pause / resume the video, MUTE to deactivate/activate the audio function and GO BACK icon to return to the event list section. You may also review recorded video file(s) with your PC. For best performance, please use “Free Video Converter” from http://www.freemake.com/free_video_converter/, or Video LAN from <http://www.videolan.org/>.

The video is using FF mpeg codes and is H.264 compression method.

User’s local network environment condition (example: upload/download speed) may cause improper video playback (black screen), when it happens, please leave the playback mode and try again at later time.

APP layout may vary depending on the display panel size of your mobile devices. Please refer to the release note from the APP Store/Google Play for more details.

To Download/Delete the video file(s) in the EVENT LIST section, please follow the steps below:

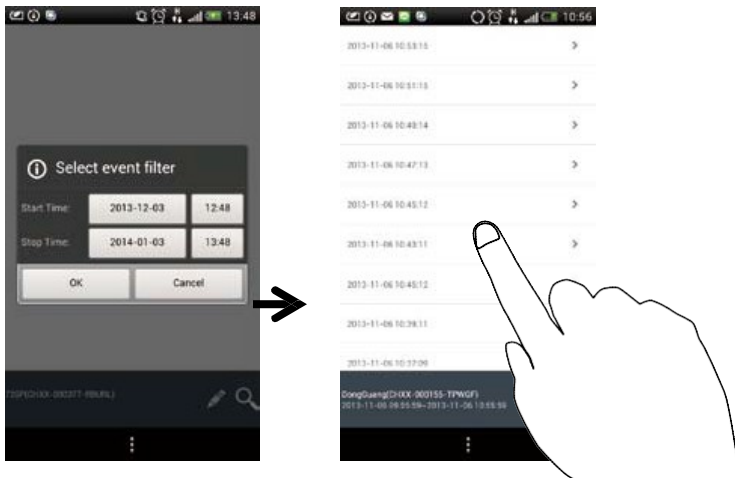

DOWNLOAD

Long press the video clip to download the file onto your mobile device.

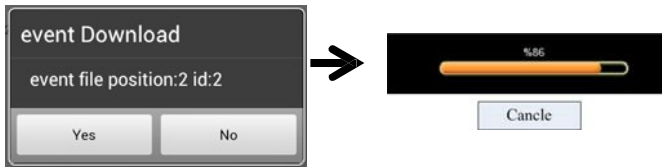

Note:

During the download process, system will stop both the live view and recording functions. APP will automatically inform any user accessing the camera that the system is busy and the connection has been terminated.

This function helps user to easily withdraw the recorded file(s) from the memory card. It is strongly suggested to download the files at your home Wi-Fi network (WLAN), meaning the mobile device(s) is connecting to the same Wi-Fi router as the camera. Minimum bandwidth requirement is 1Mbps (upload/download). Download process may be force stopped if the bandwidth becomes too slow and cannot continue.

Note:

For iOS system, please use "Oplayer Lite" APP for playback downloaded video file (s) You can find "Oplayer Lite" from App Store (free of charge)

Note:

For Android system, please use "MX Player" APP for playback downloaded video file(s). You can find "MX Player" from Google Play (free of charge).

If you are experiencing scattering video image, please switch the decoder function of the MX Player to "S/W Decoder".

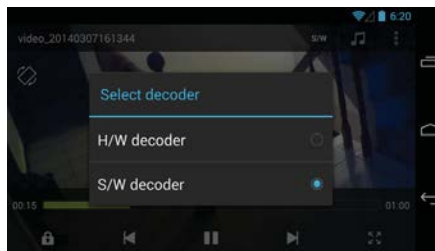

DELETE

First select the file(s) by tapping the file name, following by taping on the Trashcan icon to delete selected file(s). Multiple file(s) can be selected for delete.

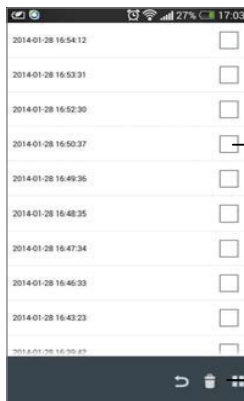

Check the video clip

Then tap the trash can icon

MAIN PAGE OVERVIEW

The MAIN PAGE section offers user an overview for all registered camera(s), including camera status (connected/disconnected). User can quickly access the camera(s) in the list. When multiple cameras are registered, scroll down to locate the registered camera for access.

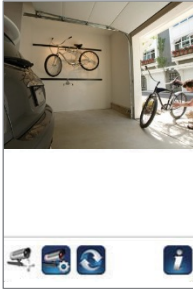

(iOS)



(Android)

ADD CAMERA



The ADD CAMERA icon allows you to register additional camera(s) to the system. The system supports up to 3 concurrent user connections.

1. Connect the additional camera to the Wi-Fi router using the provided Ethernet cable. The Wi-Fi router must be the same as what your mobile device is connecting with.
2. Tap the ADD CAMERA icon. The System Information panel appears. Specify a name or use the default system name for your camera in the SYSTEM NAME field.
3. Enter the DID code that provided with your camera in the DID column.
4. Enter the default password 123456 in the Security Code column.

System Information

System Name:

DID:

Security Code:

5. Click SAVE to complete the camera settings. The APP attempts to establish camera connection. Once the camera is successfully connected, the "Connected" status will be shown on the left upper corner.
6. Repeat step 2 to 5 to add more cameras.



In the CAMERA SETTING section you will allow to (1) configure system setting, (2) unregister camera from the APP and (3) enter event list for recorded video file(s) playback. Tap the CAMERA SETTING icon to enter/exit CAMERA SETTING.

Tap the CAMERA SETTING icon. The following icons appear on the panel.



(iOS)



(Android)



Tap the ADVANCED SETTING icon to setup camera configuration. (Please refer to "Advanced Setting" for detail).



Tap the DELETE icon to remove the camera connection.



Tap the EVENT LIST icon to check or playback the recorded events. (Please refer to "Playback Your Video" for detail).



The INFORMATION icon allows you to enable PIN lock, push notification function and check the App information.

SETUP PIN LOCK

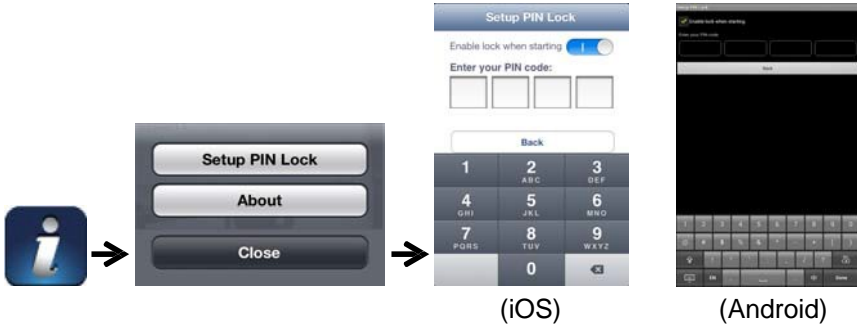

If you enable PIN Lock, the user will be asked to enter the PIN code when you launch the APP.

1. Enable the "Enable lock when starting" function. Then enter your PIN code.
2. Confirm your PIN code again.

NOTIFY (PUSH NOTIFICATION)

The WAPP camera supports motion detection function. When any event is detected in the camera site, you'll receive push notification on the mobile devices for the event recognized by the camera.

For iOS

If you want to enable/disable it, please follow the steps on your iOS mobile device:

1. Launch **Settings** from your Home screen.
2. Tap **Notifications**.
3. Scroll down to find "**OMGuard HD**" APP and tap on it.
4. Switch the toggle to **ON/OFF** in Notification Center.

Note:

It takes time for the changes to take effect in iOS, normally within 2 hours.

For Android

If you want to enable/disable it, please follow the steps below.

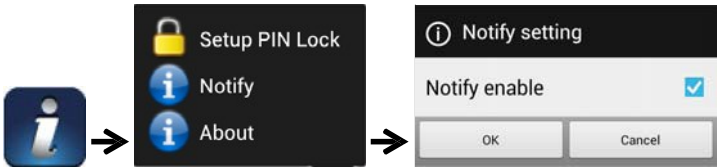

Note:

The internet connection and wireless network interference may influence the performance of push notification service.

ABOUT APP/API Version Info

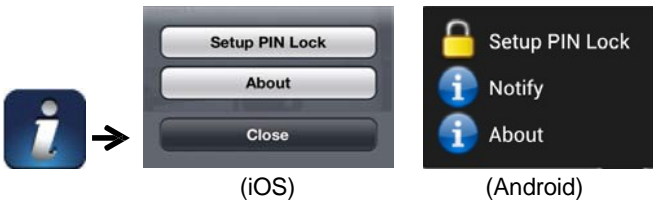

Tap the ABOUT icon to check the APP Version when necessary.

ADVANCED SETTING

This chapter explains the advanced settings for administrator. Administrator is the one who owns the administration password and has the full control to the WAPP camera. The administrator can access all WAPP functions and settings, while general users can receive the surveillance images for live view/screen capture/video recording and may not manage the camera settings.

Admin Password	The security code required to enter Advanced Setting for system setting management
Email Alert	Enable / Disable receiving E-Mail alert (after system detecting motion) on your mobile device. Please make sure you have setup the E-Mail Setting correctly and have activated Motion Detection function.
Time Zone	Setup the appropriate time zone
Daylight saving	Turn ON/OFF the daylight saving function.
Device Security Code	The password required for remote access
Video Setting	Configure the video quality and local power frequency
Wi-Fi Setting	Manage your Wi-Fi Network
Sensitivity Setting	Setup the camera sensitivity for motion detection
Email Setting	Setup your email account for E-mail alert
SD Card Format	Format/Setup the SD card
Profile Setting	Save the current camera settings and apply the settings to other cameras
Device Information	Check the App and API Kernel version



ADMIN PASSWORD

The Admin Password is a specific security code for administrator to change the advanced settings. The default admin password is 123456. Please use this function to change the default admin password into your personal admin password. For the protection of your system configuration, every time you change the advanced settings, you need to enter the admin password. Please change the admin password periodically.



EMAIL ALERT

The camera supports the motion detection function, which is capable of detecting movements within the camera view, following with notifying user the sudden event with push notification and/or email alert, system can also begin recording.

When motion detection is enabled and system detects movement:

- System will begin recording.
- With Push Notification enabled, system will send out notification message user's mobile device.
- With Email Alert enabled, system will send out Email to alert user the event.

Function	Setting	Action (when movement is detected)
Email Alert	ON	Camera: Start video recording Email account: Email alert
Push Notification	ON	Camera: Start video recording Mobile Device: Text notification
Detection	OFF	Camera: Manual Recording Email account: No action Mobile Device: No action

Note:

By default, the system has been limited to send out the email alert every 1 minutes to prevent overloading user's email account.

TIME ZONE

The drop-down list shows the world time zone. Select the time zone that will work the best for you. If your date/time is during the daylight saving time period, please check the Daylight Saving box to adjust the system time properly.

DAYLIGHT SAVING

Activate/Deactivate the daylight saving function.

DEVICE SECURITY CODE

The Device Security Code is a specific security code to access the camera. The default password of the camera is 123456. Please use this function to change the default password into your personal security code.

1. Type in the old password.
2. Type in the new password and confirm the new password again.
3. Tap OK to save the setting.



VIDEO SETTINGS

This section allows you to configure the video quality and environment mode.

Video Quality

The Video Quality setting section allows you to adjust the quality of the video streaming. By selecting better video image will allow you to view high resolution image. By selecting better streaming will allow the video to display more smoothly (quality depend on local internet environment).

Only select better image when you have sufficient bandwidth and updated mobile device(s). Please refer to P.4 for system requirement.

Environment Mode

The Environment Mode settings allows you to select the power line frequency used at the location of WAPP camera. The power line frequency varies depending on geographic region. It may cause image flicker if wrong frequency is selected. Please check with local authorities for proper setting.

Low Light Enhancement

The Low Light Enhancement Mode is for improving the night view video image by providing 5 levels to select from (5 = brightest).

WI-FI SETTING

The Wi-Fi setting allows you to choose the wireless connection and setup the Wi-Fi environment.

When you tap the “Manage Wi-Fi network” button, the system automatically scans the nearby network and shows the available Wi-Fi routers in the drop-down list. Choose the appropriate Wi-Fi router and enter the Wi-Fi router password if necessary. Due to security concerns, it is suggested to use the WPA/WPA2/ WPA2-PSK protocol for Wi-Fi network.

SENSITIVITY SETTING

This defines the camera parameter for motion detection.

Motion Detection (available for Software Mode ONLY)

HIGH – Suitable for detecting smaller object(s) within 5 to 6 meters

LOW – Suitable for detecting larger object(s) within 3 to 5 meters

EMAIL SETTING

The email setting allows you to configure the email environment, email account and password. Gmail account is suggested.

Click the “Use SSL” check box will transmit the data in encryption. This setting requires the Simple Mail Transfer Protocol (SMTP) configuration. Most ISPs use the SMTP method to transfer outbound mail via the internet. Only use the SMTP that supports SSL.

Gmail Setting (suggested)		
SMTP Server	smtp.gmail.com	Enter the gmail SMTP server
SMTP Port	465	Enter the SMTP port 465
Username	XXX@gmail.com	Enter your email address
Password	XXXXXXXX	Enter the password for this gmail account
Email to	XXX@gmail.com	Enter the email address for the recipient who receives the email alert.

SD CARD SETTING

Formatting your memory card will **ERASE** all the data from it and you will not be able to get the data back. Please back up your video files **BEFORE** formatting the memory card.



OVERWRITE SD CARD

This function will overwrite the oldest files when the micro memory card is full. Turning on this function will enable the system to start overwriting the old files when the available memory card capacity is not enough. This ensures the most up to date video recordings can be saved so that you won't miss any important information.



PROFILE SETTING

This function allows you to save the following customized settings of camera. This is useful if you want to apply the same settings to another WAPP camera quickly. You won't have to make all settings for each camera manually.

- Time zone
- Video setting
- Sensitivity setting
- Email setting
- Overwrite Setting

DEVICE INFORMATION

This section shows the device information about the camera, including device version, total size and available size of the memory card.

TROUBLE SHOOTING

IF...	SOLUTION
<p>The APP cannot found the camera</p>	<ul style="list-style-type: none"> • Make sure your network supports the DHCP protocol. • Make sure the camera and your mobile device connect to the same Wi-Fi router for the first setting. • Make sure the Wi-Fi router is activated. • Make sure the camera is properly powered on. • Use the “ADD CAMERA” function to manually add the camera.
<p>Wi-Fi router is not shown in the drop down list</p>	<ul style="list-style-type: none"> • Make sure SSID broadcasting function is enabled in the Wi-Fi router. Consult your Wi-Fi router manufacturer for the settings if necessary. • Change the wireless security protocol of your Wi-Fi router into WPA/WPA2/WPA2-PSK. Due to security concerns, WEP protocol is not suggested for some Wi-Fi routers. <p>Note: WPA/WPA2/WPA2-PSK encryption protocols are newer and more effective security standards for wireless networks than the older and less-secure WEP protocol.</p>
<p>No image appears</p>	<ul style="list-style-type: none"> • Make sure the power adaptor is not damaged or defective and plugged into an electrical outlet with power. • Relocate the camera to obtain the best reception of wireless signals. • Make sure the camera is properly confi in App. • Make sure the mobile device is connected to 3G/4G/Wi-Fi properly.

<p>Low wireless signal Poor image quality</p>	<ul style="list-style-type: none"> • Wireless devices such as wireless home stereo system may reduce the signal strength. Leave as much space as possible between the camera/mobile device and these wireless devices. • Clean the camera lens using lens cleaning cloth. Spots or dust on the lens can also cause image quality problems.
<p>Motion detection is not working or over-react</p>	<ul style="list-style-type: none"> • Make sure the sensitivity setting is turned ON (please refer to the Sensitivity Setting section). • In motion detection mode, a moving object within the camera viewing angle is necessary to trigger the motion sensor for recording
<p>The APP cannot record any video clips</p>	<ul style="list-style-type: none"> • Make sure the SD card has been correctly inserted • Make sure the motion detection function has been enabled. (please refer to the Sensitivity Setting section). • Please format the SD card when it is used for the first time (please refer to the SD Card Format section) • Make sure you are using Class 10 rated memory card.
<p>Email alert is not working</p>	<ul style="list-style-type: none"> • Make sure the email alert function is enabled (please refer to the Email Alert section). • Gmail account is suggested for the email alert function. Make sure you have setup the system configuration as suggested in the Email Alert section • Make sure the email address is has been correctly entered.

<p>Bright white spots appear at night time</p>	<ul style="list-style-type: none"> • The camera's infrared LEDs produce invisible light that reflects off surfaces such as glass. Install the camera on the other side of windows or place the lens fl against the surface to improve the night vision. It is suggested to install camera(s) under well-lit area. <p>Note: Please check the environment rating (Ingress) of the camera(s) before installing outdoors.</p>
<p>Memory card error</p>	<ul style="list-style-type: none"> • Make sure the memory card is correctly inserted and formatted. • Use the provided memory card within the package to ensure proper operation. • Make sure your are using Class 10 rated memory card. <p>Note: Please backup the data before formatting. Format function will erase all the data on the memory card.</p>
<p>Wrong data and time are shown.</p>	<ul style="list-style-type: none"> • Wrong date and/or time will result in unexpected record schedule. Make sure you've selected the correct time zone (please refer to the Time Zone section). • Confirm the system date/time of the mobile device to ensure correct operation. • System will clock itself when connect to the internet. Make sure the system is connected properly to the internet. You may use your mobile device to access the system to see if remote view is functioning properly.

PRODUCTION SPECIFICATION

Networking Parameter	
Wireless Technology	IEEE 802.11 b/g/n
Network Connection	Ethernet (10/100 Base-T/Base -TX); Wi-Fi
Network Protocols	TCP/IP, UDP, SMTP, NTP, DHCP, ARP
Simultaneous Viewers	3 concurrent sessions
Security	WPA /WPA2/WPA2-PSK (TKIP, 128 bit AES)
Camera Parameter	
Image Sensor	Mega pixel CMOS
Antenna	3dBi Dipole
Environment Rating (Ingress)	Indoor Plastic
Light Source Environment	Indoor (50Hz); Indoor(60Hz); Outdoor
Local Storage	Micro SD Card memory (not included in the package)
Pan/Tilt	Pan: 270° (9.74° each step) Tilt: 110° (9.56° each step)
Viewing angle	H:75°±3°, V: 45°±3°
Lens	2.8mm+_5%mm
Min. Illumination	1~8 lux
Number of LEDs	5 IR LEDs with IR switcher
IR Distance	5~8 meters
Video Audio Parameter	
Image Compression	H.264
Image Resolution	HD 1280x720
Recording Frame Rate	720P@20 FPS
Supported Mobile Device	
iOS requirement	iPhone 4S / iPad Mini / iPad 2 with iOS 7.0 or above
Android requirement	Android 4.1X or above
Hardware requirement	1.5GHz dual core or above 1GB or above internal memory
General Parameter	
Power Requirements	100~240V switching power supply DC 5V 1.5A
Operating Temperature	-10°~+50°C

STORAGE MEDIA MANAGEMENT



4G

220

220

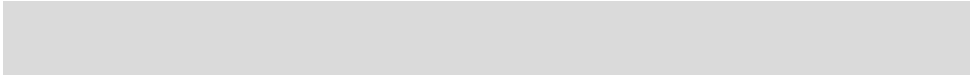

16G

880

880

