

smartwares® GWL-001-HS

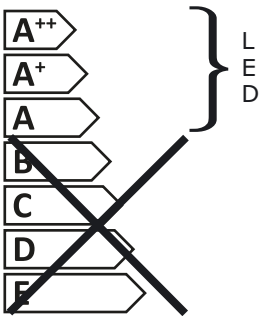

Diese Leuchte enthält eingebaute LED-Lampen.



Die Lampen können in der Leuchte nicht ausgetauscht werden.

874/2012



smartwares® GWL-001-HS



Ce luminaire est comporte des lampes à LED intégrées.

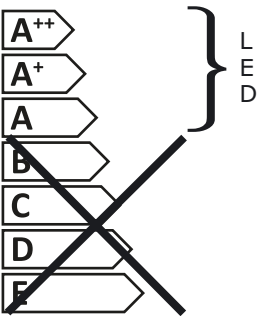

Les lampes de ce luminaire ne peuvent pas être changées.

874/2012



smartwares® GWL-001-HS



This luminaire contains built-in LED lamps.

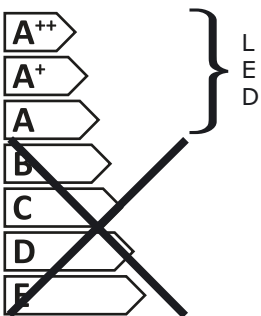

The lamps cannot be changed in the luminaire

874/2012



smartwares® GWL-001-HS



Deze armatuur bevat ingebouwde LED-Lampen.

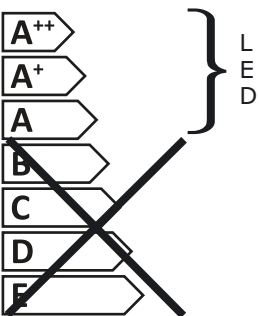

In de armatuur kunnen de lampen niet worden vervangen.

874/2012



smartwares Europe	
Jules Verneweg 87 5015 BH Tilburg The Netherlands	
service.smartwares.eu	
NL: 088 5940501	Lokaal tarief
BE: 078 481094(NL)	Lokaal tarief
BE: 078 481540(FR)	Tarif local
FR: 0825 560 650	18ct/min
DE: +49 (0) 1805 010762	14ct./Min. dt. Festnetz.
	Mobil max. 42ct./Min
UK: +44 (0) 345 230 1231	
ES: +34 938427589	



smartwares®



OUTDOOR USE



INCL. NUMBER STICKERS



ALUMINIUM



LED outdoor light

NL LED buitenlamp DE LED-Außenleuchte FR Luminaire extérieur
ES Luz exterior LED IT Lampada a LED da esterno PT Luz exterior LED SE LED utomhuslampa TR
LED dışmekan lambası PL Zewnętrzne oświetlenie diodowe.

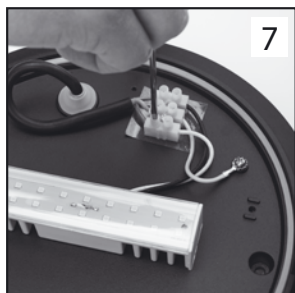
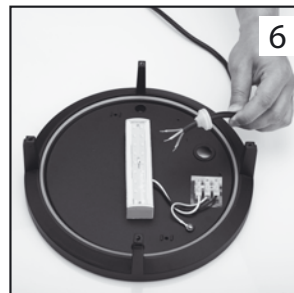
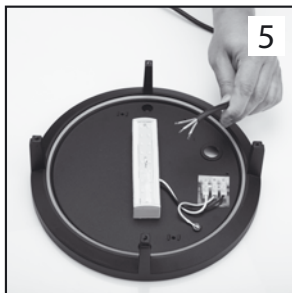
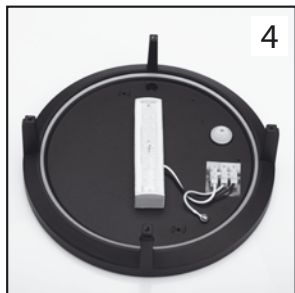
GWL-001-HS - 10.027.25



 **OUTDOOR USE**
 **220-240V~ 50-60Hz**
 **IP54**
 **7 WATT**
 **350 LUMEN**
 **25.000 HOURS**
 **NOT DIMMABLE**
 **ON / OFF ≥15.000x**

 **Ra >65**
 **2700K 6500K**
2700K WARM LIGHT

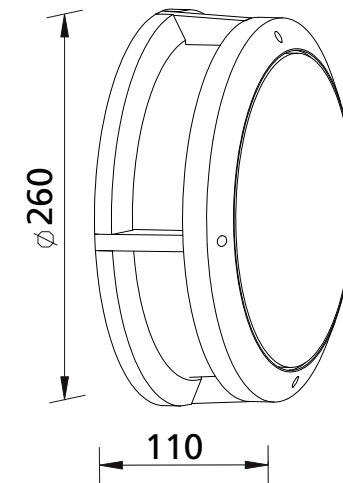

IP54



- GB** The fixture is dust and splash proof
- NL** Het armatuur is stofvrij en spatwaterdicht
- F** L'installation est à l'épreuve des éclaboussures et de la poussière.
- D** Die Leuchte ist staub- und spritzwassergeschützt
- N** Armaturetøstøv- og sprutsikkert.
- S** Armaturen är damm- och stänkskyddad
- DK** Armaturet er støv- og stænktæt
- FIN** Valaisin on pöly- ja roiskesuojattu
- PL** To urządzenie jest odporne na kurz i zachlapania
- RUS** Светильник пыленепроницаемый и брызгозащитный
- BG** Часта е устойчива на прах и пръски вода
- H** A rögzítő por- és fröccsenésálló
- RO** Dispozitivul de fixare este rezistent la praful și la stropire
- SK** Svetidlo neprepúšťa prach ani výšplachnutú kvapalinu.
- HR** Armatura je zaštićena od prašine i prskajuće vode
- CZ** Armatura je prachotěsná a krytá proti stékající vodě
- SLD** Svetilo je odporno na prah in pršenje vode
- I** L'attacco è resistente a polvere e spruzzi
- P** A armadura de iluminação é à prova de poeira e salpicos
- E** El aplique es resistente a polvo y salpicaduras
- GR** Το στηρίγμα είναι αδιαπέραστο από τη σκόνη και αδιάβροχο
- TR** Aparat su ve toz geçirmez.
- GB** Protection class 1: the fitting must be earthed.
- NL** Beschermklasse 1, het armatuur moet geaard worden.
- F** Classe de sécurité 1, l'armature doit être mise à la terre.
- D** Schutzklasse 1, die Armatur muss geerdet werden.
- N** Beskyttelsesklasse 1: armaturet må jordes.
- S** Skyddsklass 1, armaturen måste jordas.
- DK** Beskyttelsesklasse 1, armaturet skal have jordforbindelse.
- FIN** Suojausluokka 1, valaisin pitää maadoittaa.
- PL** Klasa zabezpieczenia 1: urządzenie musi być uziemione.
- RUS** Класс защиты 1: арматура должна быть заземлена.
- BG** Защита от клас 1: осветителното тяло трябва да е заземено.
- H** 1. védelmi osztály: a szerelvény földelhető.
- RO** Clasă 1 de protecție: corpul de iluminat trebuie împământat.
- SK** Trieda ochrany 1: zariadenie musí byť uzemnené.
- HR** Klasa zaštite 1: svjetiljka mora biti uzemljena.
- CZ** Třída ochrany 1: zařízení musí být uzemněno.
- SLD** Zaščitni razred 1: nosilec senzorja je potrebno ozemljiti.
- I** Classe di protezione 1, la lampada deve avere la messa a terra.
- P** Classe 1 de protecção: a ferragem de conexão deve ser ligada à terra.
- E** Protección de Clase 1: el montaje debe estar conectado a tierra.
- GR** Προστατευτικό γυαλί 1: η εφαρμογή πρέπει να γειωθεί.
- TR** Emniyet türü 1: Tertibat topraklanmalıdyr.